



# Battery-Box Premium Operating Manual

HVS 5.1, 7.7, 10.2, 12.8

HVM 8.3, 11.0, 13.8, 16.6, 19.3, 22.1

A High Voltage Battery System



BYD Smart Device Hungary Kft. V1.7

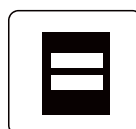

Be Connect



## Legal Provisions

All the information in this document is the property of BYD Smart Device Hungary kft. No part of this document could be reproduced in any way for business use. Internal use is allowed.

BYD Smart Device Hungary kft. makes no representations or warranties express or implied, with respect to this document or any of the equipment and/or software it may describe, including (with no limitation) any implied warranties of utility, merchantability, or fitness for any particular purpose. All such representations or warranties are expressly disclaimed. Neither BYD Smart Device Hungary kft. nor its distributors or dealers shall be liable for any indirect, incidental, or consequential damages under any circumstances.

The exclusion of implied warranties may not apply in all cases under some statutes, and thus the above exclusion may not apply.

This document does not replace and is not intended to replace any local, state, provincial, federal, or national laws, regulations, or codes applicable to the installation, electrical safety, and use of the battery system. BYD Smart Device Hungary kft. assumes no responsibility for the compliance or noncompliance with such laws or codes in connection with the installation of the battery system.

Specifications are subject to change without notice. Every effort has been made to make this document complete, accurate, and up-to-date. However, BYD Smart Device Hungary kft. may need to make some improvements under certain circumstances without advance notice. BYD Smart Device Hungary kft. shall not be responsible for any loss caused by this document, including, but not limited to, omissions errors, typographical errors, arithmetical errors, or listing errors in this document.

All trademarks are recognized.

### **Limited Warranty**

You can download the latest Limited Warranty from the Internet at [www.bydbatterybox.com](http://www.bydbatterybox.com).

**BYD Smart Device Hungary kft.**

H-2071 Páty, Szent József út 4.

# Content

Legal Provisions .....	1
1. Information on this Document .....	4
1.1. Validity .....	4
1.2. Target Group .....	4
1.3. Content and Structure of this Document .....	4
1.4. Declaration of Conformity .....	4
1.5. Levels of Warning Messages .....	4
1.6. Symbols in the Document .....	5
1.7. Designation in the Document .....	5
2. Safety .....	6
2.1. Intended Use .....	6
2.2. IMPORTANT SAFETY INSTRUCTIONS .....	6
2.2.1. Battery Module Leakage .....	6
2.2.2. Firefighting Measures .....	6
2.2.3. Battery Modules Handling and Storage Guide .....	7
2.2.4. Warning of Electric Shock .....	7
2.2.5. Warning of Overvoltages .....	8
2.2.6. Caution of Weight .....	8
2.2.7. Notice of Property Damage .....	8
3. Scope of Delivery .....	9
4. Battery System Overview .....	10
4.1. Battery System Description .....	10
4.2. Interface .....	11
4.3. Symbols on the System .....	12
4.4. LED Signals .....	13
5. Installation .....	14
5.1. Requirements for Installation .....	14
5.1.1. Requirements for Installation Location .....	14
5.1.2. Tools .....	15
5.1.3. Safety Gear .....	15
5.1.4. Additionally Required Installation Material .....	15
5.2. Installation .....	16

6.	Electrical Connection .....	18
6.1.	Overview of the Connection Area.....	18
6.2.	Connection Diagram .....	20
6.2.1.	One Battery System .....	20
6.2.2.	Multiple Battery Systems .....	21
6.3.	Connecting the Grounding Conductor .....	21
6.4.	The Data Cable Connection to Inverter .....	23
6.4.1.	Connection Options .....	23
6.4.2.	Connecting the Data Cable of the Inverter .....	23
6.5.	Connecting the Data Cable for other Battery System(s).....	24
6.6.	Connecting the Network Cables.....	26
6.7.	DC Connection .....	27
6.8.	Close up .....	28
7.	Commissioning .....	29
7.1.	Switch on the Battery System .....	29
7.2.	Configure the Battery System .....	30
7.3.	Switch on and Commission the Inverter .....	32
8.	Operation .....	34
8.1.	Switch on the Battery System .....	34
8.2.	Switch off the Battery System .....	34
8.3.	Safety Design .....	35
8.4.	Black Start Function.....	35
8.5.	WLAN.....	35
9.	Decommissioning.....	36
10.	Extension .....	37
11.	Troubleshooting .....	38
11.1.	Battery System Behavior under Fault Conditions.....	38
11.2.	LED Light Designation for Errors .....	38
12.	Maintenance and Storage .....	40
13.	Disposal of the Battery System.....	41
14.	Technical Data .....	42
15.	Contact Information .....	44
	Appendix Connection Options with Inverters.....	45



# 1. Information on this Document

## 1.1. Validity

This document is valid for the Battery-Box Premium HVS 5.1, 7.7, 10.2, 12.8, and HVM 8.3, 11.0, 13.8, 16.6, 19.3, 22.1 from firmware BMU 3.15, BMS 3.22.

## 1.2. Target Group

The instructions in this document may only be performed by qualified persons who must have the following skills:

- Knowledge of how batteries work and are operated
- Knowledge of how an inverter works and is operated
- Knowledge of, and adherence to the locally applicable connection requirements, standards, and directives
- Knowledge of, and adherence to this document and the associated system documentation, including all safety instructions
- Training in dealing with the hazards associated with the installation and operation of electrical equipment and batteries
- Training in the installation and commissioning of electrical equipment

Failure to do so will make any manufacturer's warranty, guarantee or liability null, and void unless you can prove that the damage was not due to non-compliance.

## 1.3. Content and Structure of this Document



This document contains safety information and instructions, scope of delivery, system overview, installation, electrical connection, commissioning, decommissioning, expansion, troubleshooting, maintenance and storage, disposal, and technical data. Please finish reading this document before taking any actions on the battery system.

## 1.4. Declaration of Conformity

The battery system described in this document complies with the applicable European directives. The certificate is available in the download area at [www.bydbatterybox.com](http://www.bydbatterybox.com).

## 1.5. Levels of Warning Messages

The following levels of warning messages may occur when handling the battery system.

 <b>DANGER</b>
Indicates a hazardous situation which, if not avoided, will result in death or serious injury.
 <b>WARNING</b>
Indicates a hazardous situation which, if not avoided, could result in death or serious injury.

**! CAUTION**

Indicates a hazardous situation which, could result in minor or moderate injury.

**NOTICE**

Indicates a situation which, if not avoided, can result in property damage.

### 1.6. Symbols in the Document

**! QUALIFIED PERSON**

Sections describing activities to be performed by qualified persons only.

### 1.7. Designation in the Document

Designation in this document	Complete designation
battery system	Battery-Box Premium HVS&HVM
BCU	Battery Control Unit
BCP	Be Connect Plus
BIC	Battery Information Collector
BMS	Battery Management System
BMU	Battery Management Unit
BYD	BYD Smart Device Hungary kft.
SOC	State of Charge

## 2. Safety

### 2.1. Intended Use

The battery system is for residential and works with a photovoltaic system. It is a high voltage Li-ion battery storage system, with the control module on itself. It could be operated in on-grid, off-grid and backup modes with compatible inverters.

The battery system could be connected to the internet through network cable for maintenance and firmware updating.

The battery system must only be used as stationary equipment.

The battery system is suitable for indoor and outdoor use under the conditions mentioned in Section 5.1.

The battery system must only be operated in connection with a compatible inverter. The list (BYD Battery-Box Premium HVS & HVM Compatible Inverter List) of these inverters could be found at [www.bydbatterybox.com](http://www.bydbatterybox.com).

The battery system is not suitable for supplying life-sustaining medical devices. Please ensure that no personal injury would lead due to the power outage of the battery system.

Alterations to the battery system, e.g., changes or modifications are not allowed unless the written permission of BYD is achieved. Unauthorized alterations will void the guarantee and warranty claims. BYD shall not be held liable for any damage caused by such changes.

The type label should always be attached to the battery system.

### 2.2. IMPORTANT SAFETY INSTRUCTIONS

The battery system has been designed and tested in accordance with international safety requirements. However, in order to prevent personal injury and property damage and ensure long-term operation of the battery system, please do read this section carefully and observe all safety information at all times.

#### 2.2.1. Battery Module Leakage

If the battery modules leak electrolytes, contact with the leaking liquid or gas should be avoided. The electrolyte is corrosive, and the contact may cause skin irritation and chemical burns. If one is exposed to the leaked substance, do these actions:

**Inhalation:** Evacuate the contaminated area, and seek medical help immediately.

**Eye contact:** Rinse eyes with flowing water for 15 minutes and seek medical help immediately.

**Skin contact:** Wash the affected area thoroughly with soap and water and seek medical help immediately.

**Ingestion:** Induce vomiting and seek medical help immediately.

#### 2.2.2. Firefighting Measures

The battery modules may catch fire when it is put into the fire. In case of a fire, please make sure that an ABC or carbon dioxide extinguisher is nearby. Water cannot be used to extinguish the fire.

Full protective clothing and self-contained breathing apparatus are required for the firefighters to extinguish the fire.

### 2.2.3. Battery Modules Handling and Storage Guide

- The battery modules and its components should be protected from damage when transporting and handling.
- Do not impact, pull, drag, or step on the battery modules.
- Do not insert unrelated objects into any part of the battery modules.
- Do not throw the battery module into a fire.
- Do not soak the battery modules in water or seawater.
- Do not expose to strong oxidizers.
- Do not short circuit the battery modules.
- The battery modules cannot be stored at high temperatures (more than 50° C).
- The battery modules cannot be stored directly under the sun.
- The battery modules cannot be stored in a high humidity environment.
- Do not use the battery modules if it is defective, or appears cracked, broken or otherwise damaged, or fails to operate.
- Do not attempt to open, disassemble, repair, tamper with, or modify the battery modules. The battery modules are not user-serviceable.
- Do not use cleaning solvents to clean the battery modules.

### 2.2.4. Warning of Electric Shock

#### DANGER

##### **Danger to life due to electric shock when live components or DC cables are touched**

The DC cables connected to an inverter may be live. Touching live DC cables results in death or serious injury due to electric shock.

- Disconnect the battery system and inverter from voltage sources and make sure it cannot be reconnected before working on the device.
- Do not touch non-insulated parts or cables.
- Do not remove the terminal block with the connected DC conductors from the slot under load.
- Wear suitable personal protective equipment for all work on the battery system.
- Observe all safety information of the inverter manufacturer.

## 2.2.5. Warning of Overvoltages

### DANGER

#### **Danger to life due to electric shock in case of overvoltages and if surge protection is missing**

Overvoltages (e. g. in the event of a flash of lightning) can be further conducted into the building and to other connected devices in the same network via the network cables or other data cables if there is no surge protection. Touching live parts and cables results in death or lethal injuries due to electric shock.

- Ensure that all devices in the same network and the inverter are integrated into the existing surge protection.
- When laying the network cables or other data cables outdoors, it must be ensured that a suitable surge protection device is provided at the transition point of the cable from the VUlTYfmsystem or the inverter outdoors to the inside of a building.

## 2.2.6. Caution of Weight

### CAUTION

#### **Risk of injury due to weight of the battery module**

Injuries may result if the battery module is lifted incorrectly or dropped while being transported or installed.

- Transport and lift the battery module carefully. Take the weight of the battery module into account.
- Wear suitable personal protective equipment for all work on the battery system.

## 2.2.7. Notice of Property Damage

### NOTICE

#### **Damage to the BCU due to sand, dust and moisture ingress**

Sand, dust and moisture penetration can damage the BCU and impair its functionality.

- Only open the BCU if the humidity is within the thresholds and the environment is free of sand and dust.

### NOTICE

#### **Damage to the battery system due to under voltages**

- If the battery system doesn't start at all, please contact BYD local after-sales service within 48 hours. Otherwise, the battery could be permanently damaged.

### 3. Scope of Delivery

#### BCU and Base Package

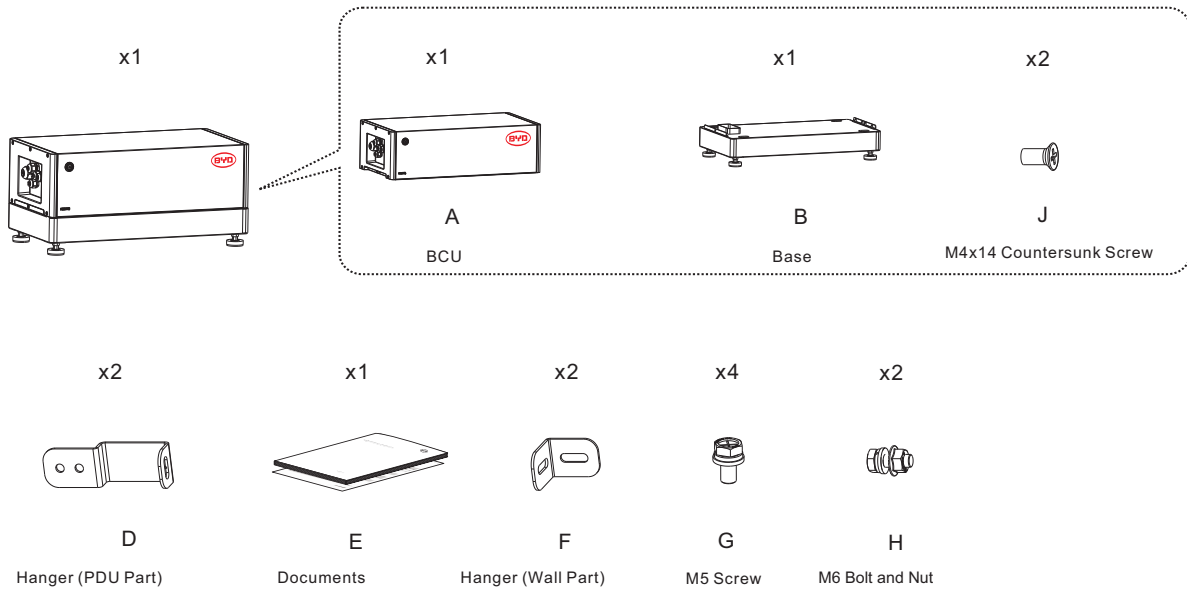

#### Battery Module package

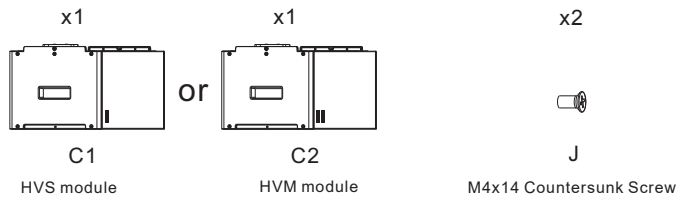

A	BCU
B	Base
C	Battery Module ( C1, HVS module; C2, HVM module )
D	Hanger (BCU part)
E	Documents (Quick Start Guide, Compatible Inverter List, Packing List)
F	Hanger (wall part)
G	Screw to fix D on BCU
H	Bolt to fix D and F
J	Screw to fix the connection between modules, base, and BCU.

## 4. Battery System Overview

### 4.1. Battery System Description

The Battery-Box Premium HVS&HVM is used as a connected battery for the intermediate storage of excess PV energy in an inverter system.

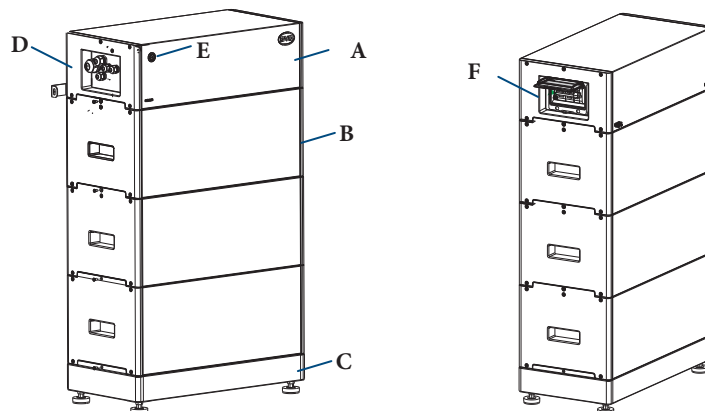

A	BCU
B	Battery Module
C	Base
D	Operating Panel
E	LED Button
F	System Switch

There are two types of battery modules, HVM and HVS. The HVM has two stripes printed on it, and the HVS has one stripes.

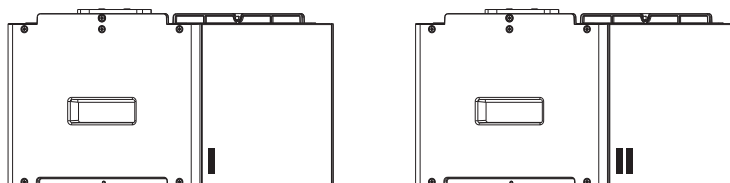

Two to five HVS battery modules or three to eight HVM battery modules could be installed in one tower. **DIFFERENT BATTERY MODULES CANNOT BE INSTALLED IN ONE TOWER.**

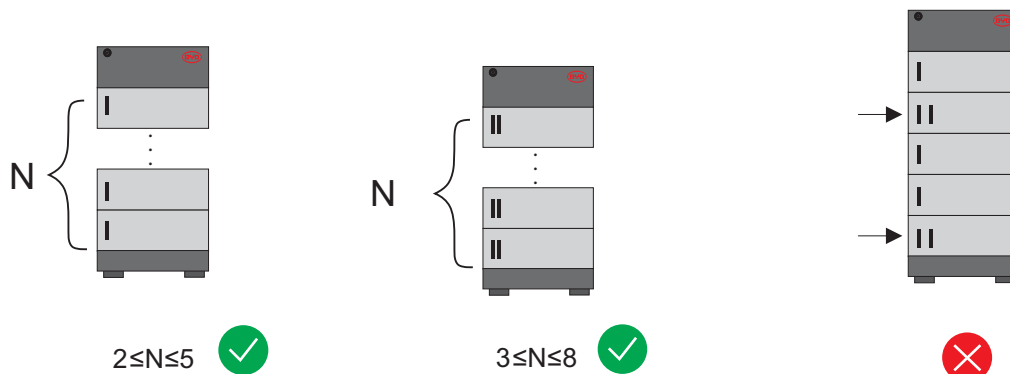

Up to three battery systems could be connected in parallel. (This restriction does not apply for parallel connection with SMA Sunny Boy Storage 3.7-6.0. Please check the inverter operation manual on how to connect up to three batteries.)

**THE HVS SYSTEM CANNOT BE CONNECTED WITH THE HVM SYSTEM.**

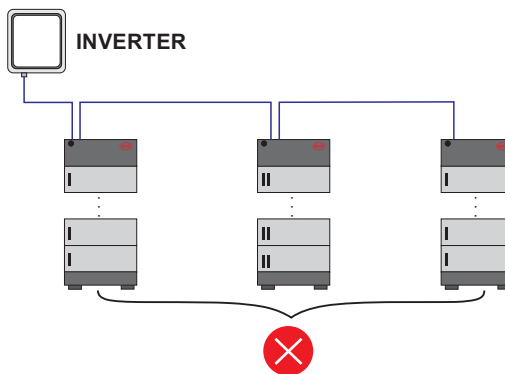

**4.2. Interface**

**Be Connect**

Be Connect is an app for Android and iOS system devices. You can download it from Google Play or App Store.

Minimum Android version 4.4 and iOS 10.0 are required for the proper operation of Be Connect.

With Be Connect, you can configure and diagnose the battery system, read the general battery information, update the firmware, etc.

**Be Connect Plus**

Be Connect Plus (BCP) is a PC app. You can download from our website (<https://www.bydbatterybox.com/downloads>).













With BCP, you can configure and diagnose the battery system, read the general battery information, events, update the firmware, download historical events, etc..

**Be Connect Monitoring**

The battery system is equipped with an Ethernet connection port as a standard. When your battery system is linked with the Internet, it will join our Be Connect Monitoring. Be Connect Monitoring is a platform for BYD to provide remote service to customers. It can diagnose your battery system, and update the firmware. It is highly recommended you to connect the battery system to the Internet to have a better service. (Currently, this interface is only open to BYD service team.)



### 4.3. Symbols on the System

Symbol	Explanation
	Observe the documents Observe all documents supplied with the system.
	Grounding conductor This symbol indicates the position for connecting a grounding conductor.
	WEEE designation Do not dispose of the system together with the household waste but in accordance with the disposal regulations for electronic waste applicable at the installation site.
	CE marking The system complies with the requirements of the applicable EU directives.
	This side up
	Handle with care
	Keep dry
	Keep the battery modules away from open flame or ignition sources
	Beware of electrical voltage
	Beware of a danger zone This symbol indicates that the system must be additionally grounded if additional grounding or equipotential bonding is required at the installation site.
	Keep the battery modules away from children
	RCM (Regulatory Compliance Mark), a brief guide to electrical equipment approvals in Australia



Do not short circuit.

#### 4.4. LED Signals

Flashing white and blue alternatively

White  ON  
OFF

Blue  ON  
OFF



The battery system is initiating.

Static white

White  ON  
OFF

Blue  ON  
OFF



Idle (the battery system is neither charging nor discharging).

Flashing white slowly

White  ON  
OFF

Blue  ON  
OFF

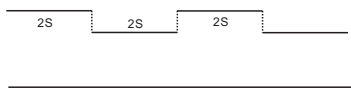

The battery system is charging.

Flashing white quickly

White  ON  
OFF

Blue  ON  
OFF

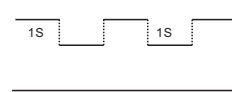

The battery system is discharging.

Flashing white and glowing blue

White  ON  
OFF

Blue  ON  
OFF

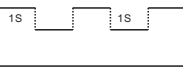

The battery system is discharging, and the SOC is below 15%.

Flashing white and blue

White  ON  
OFF

Blue  ON  
OFF

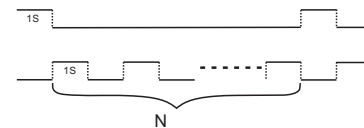

An event message has occurred (refer to service guideline and checklist for further details)

## 5. Installation

### 5.1. Requirements for Installation

#### 5.1.1. Requirements for Installation Location

- A solid support surface must be available (e.g., concrete or masonry).
- The installation location must be inaccessible to children.
- The installation location must be suitable for the weight and dimensions of the battery system.
- The installation location must not be exposed to direct solar irradiation.
- The installation location must not be close to the fire.
- The altitude of the installation location should be less than 3000m.
- The ambient temperature should be between  $-10^{\circ}\text{C}$  and  $+50^{\circ}\text{C}$ .
- The ambient humidity should be between 5-95%.



Max  $+50^{\circ}\text{C}$



Min  $-10^{\circ}\text{C}$





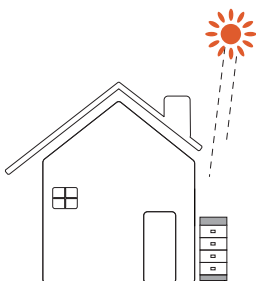
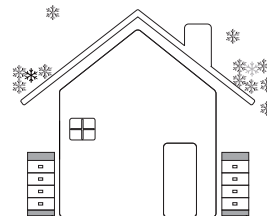
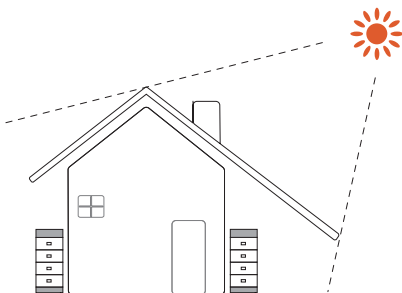
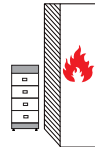
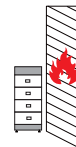



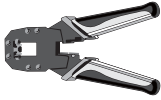

RH.  $+5\% \sim +95\%$

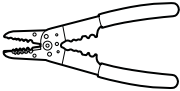
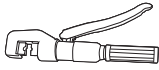

### 5.1.2. Tools

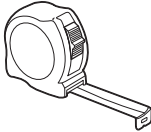
The tools in the following table could be needed during the installation.

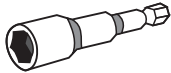





				
Network Wire Clamp	Pen	Phillips Screwdriver Bit	Flat-Head Screwdriver	Torque Wrench
				
Wire Stripper	Crimping Plier	Wrench	Tape Measure	Drill
				
Hair Dryer	Cylinder Screwdriver			

### 5.1.3. Safety Gear

Wear the following safety gear when dealing with the battery system.

		
Insulated gloves	Safety goggles	Safety shoes

### 5.1.4. Additionally Required Installation Material

x2	x2		x1	x1	x1
					
K	L	M	N	O	P
DC Cable	Expansion Anchor Bolt(M8x40)	Cat5 Shield	PE Terminal	PE	Heat Shrink Tubing

## 5.2. Installation

### ⚠ QUALIFIED PERSON

### ⚠ DANGER

#### Danger to life from electric shock due to live DC cables or connectors at the battery system

The DC cables connected to the battery system may be live. Touching the DC conductors or the live components leads to lethal electric shocks.

- Do not touch non-insulated cable ends.

### ⚠ CAUTION

#### Risk of injury due to weight of the battery module

Injuries may result if the battery module is lifted incorrectly or dropped while being transported or installed.

- Transport and lift the battery module carefully. Take the weight of the battery module into account.
- Wear suitable personal protective equipment for all work on the battery system.

#### Additionally required installation material (not included in the scope of delivery):

- Two screws suitable for the support surface (diameter: 8 mm)
- Where necessary, two screw anchors suitable for the support surface and the screws.

#### Procedure:

1. Take the BCU and base from the package out.
2. Loosen the two screws with screwdriver PH2.
3. Take the BCU from the base.
4. Put the installed base and feet along the wall, and keep the distance of 12~19 mm between the wall and the base.
5. Take a battery module from the package out. Put one battery module on the base. Pay attention to the direction of the module. The blind-mating connectors on the battery module and the base should be on the same side.
6. Repeat the operations for other battery modules.

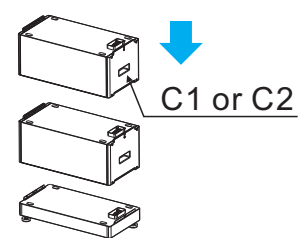
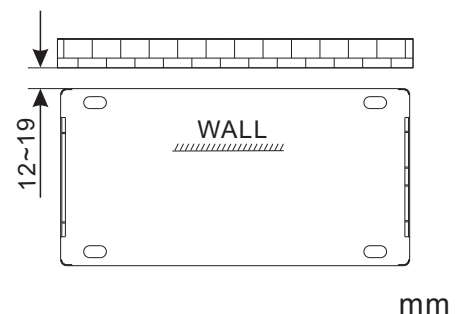
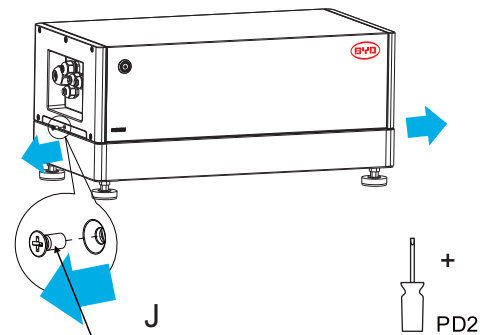

7. Install the hanger (BCU part) to the BCU. To do this, insert the screws (M5x14) through the hole on the BCU using a cylinder screwdriver (8 mm) and tighten them (torque: 5.5 Nm).

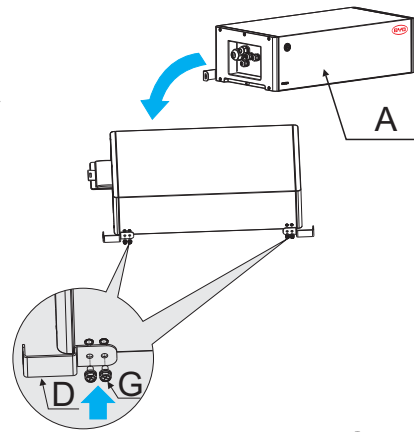

8. Put the BCU on top of the battery modules.

Recommend to connect cables on the BCU first when five or more than five battery modules are needed to be installed in one tower.

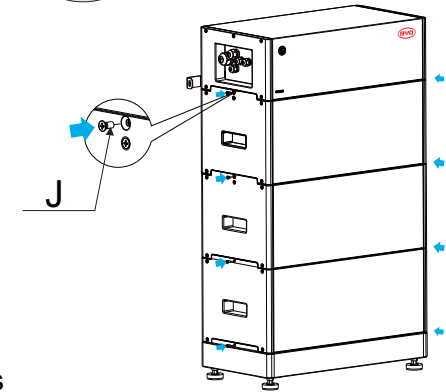

9. Fix the connection between the battery module and the base, between battery modules, and between BCU and battery module. To do this, insert the screws (M4x14) through the holes on them, using a Phillips screwdriver (PH2) and tighten them (torque: 2 Nm).

10. Hold the hanger (wall part) where it intends to be mounted on the wall and mark the position of the drill holes. Please pay attention that there may be power cables or other supply lines (e.g., gas or water) routed in the wall. Ensure that no lines are laid in the wall, which could be damaged when drilling holes.

11. Set the hanger aside and drill the marked holes.

12. Insert screw anchors into the drill holes if the support surface requires them.

13. Secure the hanger using screws (recommended M8x40).

14. Fix the two hangers (wall part and BCU part) with M6X16 bolts and nuts, using a cylinder screwdriver (10 mm) to tighten it (torque: 8 Nm).

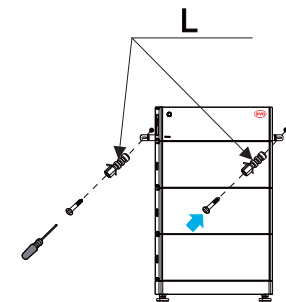

15. Mark the product type.

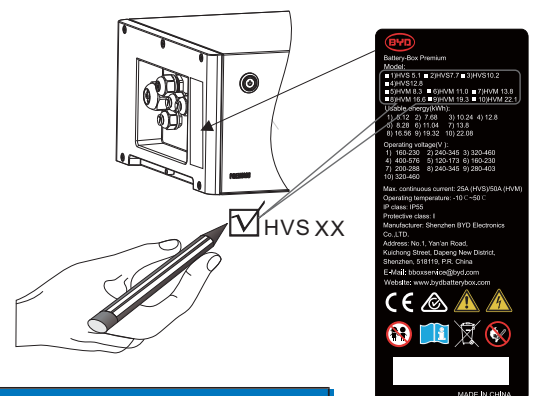

BYD	
Battery-Box Premium	
Model	
1) HVS 5.1	2) HVS 7.7
3) HVS 10.2	4) HVS 12.8
5) HVS 15.3	6) HVS 17.9
7) HVS 20.4	8) HVS 22.5
Voltage (VDC)	
1) 272	2) 288
3) 304	4) 320
5) 336	6) 352
7) 368	8) 384
Operating voltage (V)	
1) 168-230	2) 240-345
3) 320-450	4) 400-575
5) 500-675	6) 700-825
7) 900-1050	8) 1200-1400
Max. continuous current 25A (HVS) / 50A (HVM)	
Operating temperature: -10°C ~ 50°C	
IP class: IP54	
Protective class: I	
Manufacturer: Shenzhen BYD Electronics Co., LTD	
Address: No. 1, Yantao Road, Kaitang Street, Daqiang New District, Shenzhen, 518119, P.R. China	
E-Mail: hvs@byd.com	
Website: www.bydbattery.com	
MADE IN CHINA	

## NOTICE

### Damage to the battery system due to under voltages

- If the battery is installed, it should be set into operation within a month, or checked regularly, otherwise there might be damage to the batteries.

# 6. Electrical Connection

## 6.1. Overview of the Connection Area

Exterior view

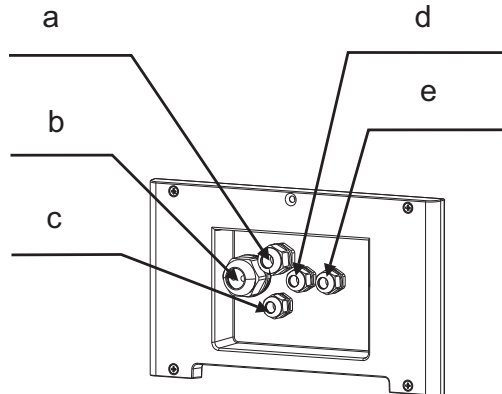

a	Gland for Ethernet cable
b	Gland for inverter and another battery system data cable
c	Gland for PE
d	Gland for DC+ (P+)
e	Gland for DC- (P-)

Interior View

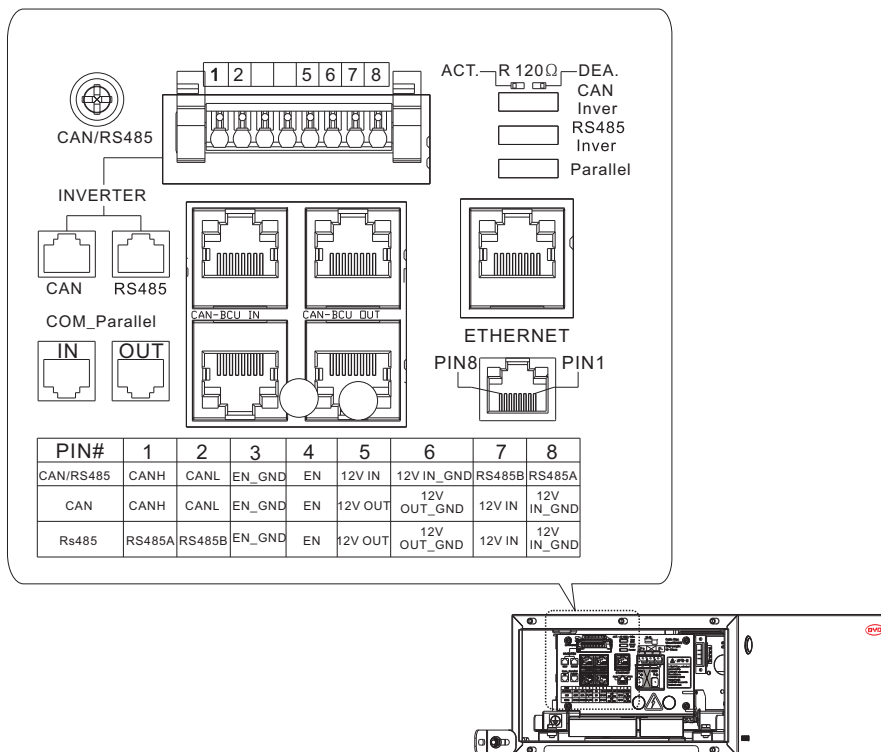

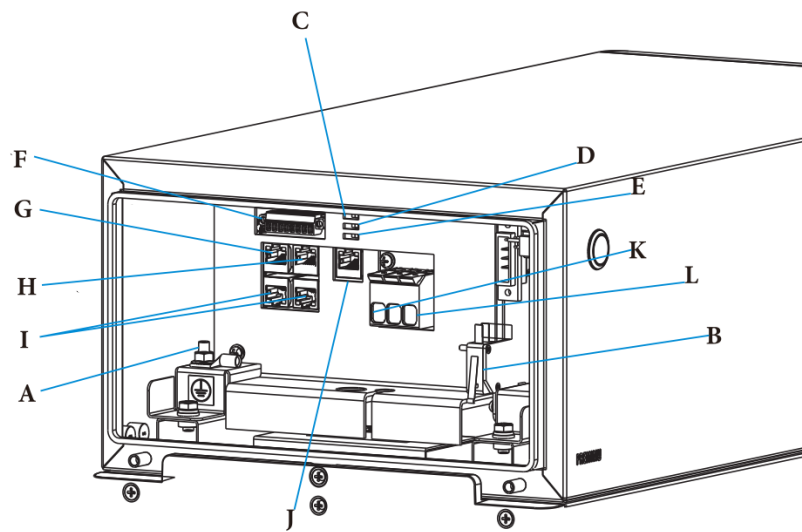

A	PE connecting point
B	Panel open sensor
C	Dip switch for the CAN protocol circuit with inverter
D	Dip switch for the RS485 protocol circuit with inverter
E	Dip switch for the CAN protocol circuit with other systems (s)
F	8 pin terminal blocks for connecting an inverter`s data cable. (CAN or RS485 protocol)
G	RJ 45 port for connecting an inverter`s data cable. (CAN protocol)
H	RJ 45 port for connecting an inverter`s data cable. (RS485 protocol)
I	RJ 45 port for connecting with other tower(s). (CAN protocol)
J	RJ 45 port for Ethernet cable connection
K	DC+ to inverter
L	DC- to inverter

The connection to Ethernet cable is recommended, not compulsory.

We provide different methods to connect inverter with the battery system. You can choose the suitable one for you.



## 6.2. Connection Diagram

### 6.2.1. One Battery System

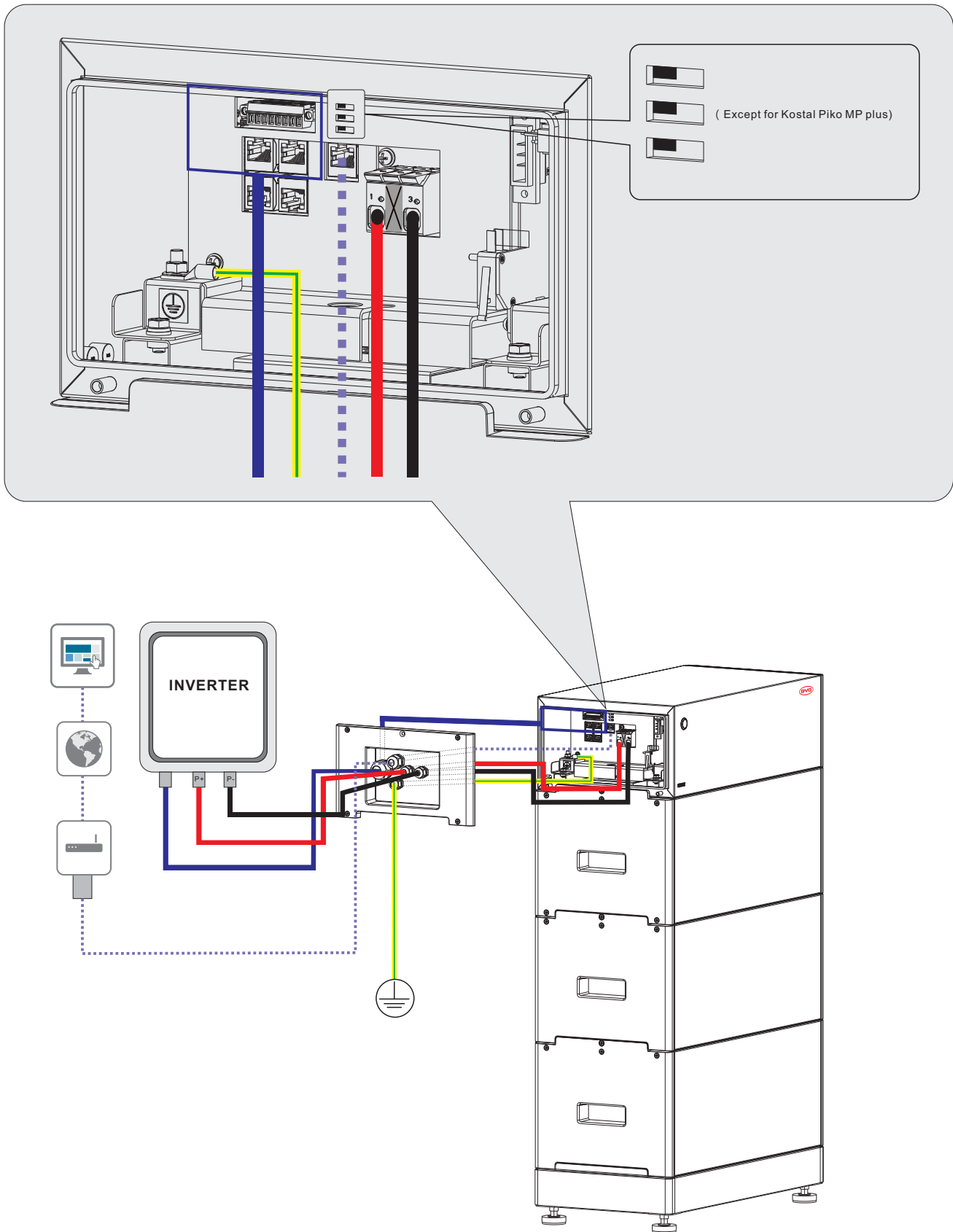

## 6.2.2. Multiple Battery Systems

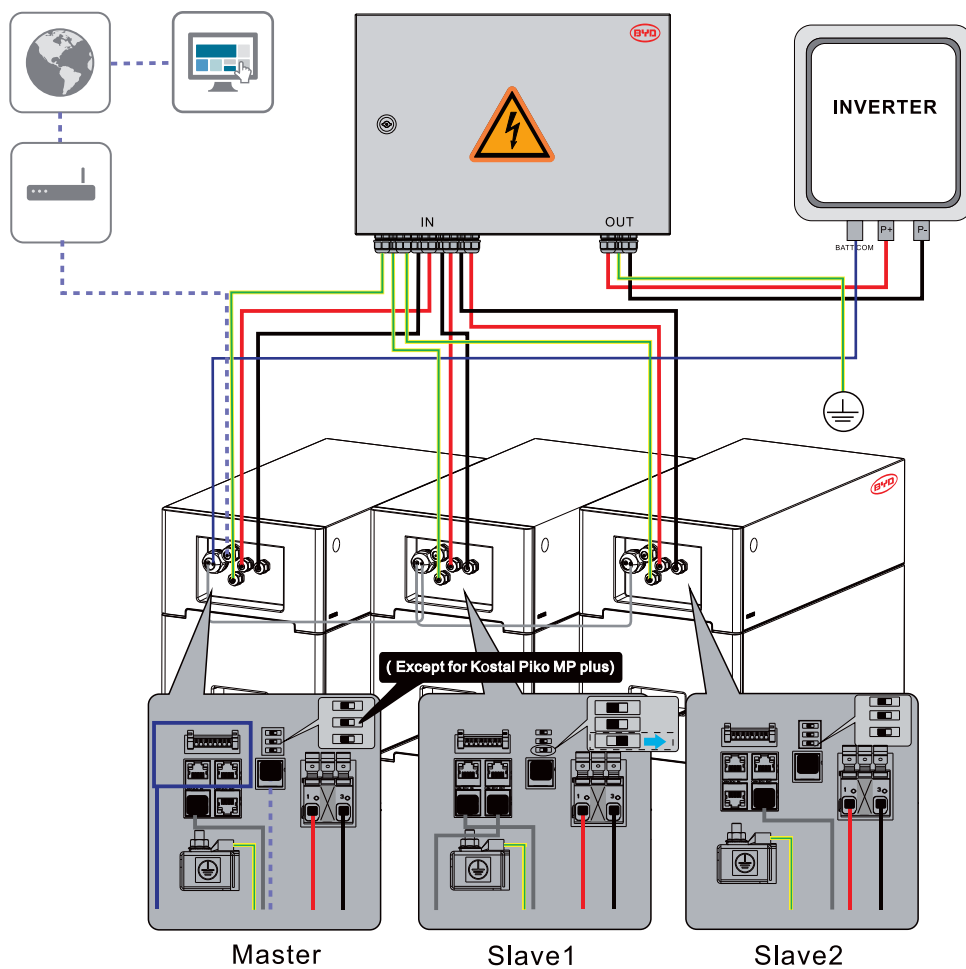

## 6.3. Connecting the Grounding Conductor

### ⚠ QUALIFIED PERSON

Additionally required mounting material (not included in the scope of delivery):

- Conductor SC10-5
- Grounding cable cross-section: 10 mm<sup>2</sup>

#### Procedure:

- Make sure the system switch of BCU is off.
- Take off the Operating Panel of BCU, with a Phillips screwdriver PH2.

3. Take out the plug on cable gland c.
4. Take off the nut of the cable gland.
5. Take off the cable support sleeve inside of the cable gland.
6. Get the PE inside of the cable support sleeve.
7. Lead the PE through cable gland c.

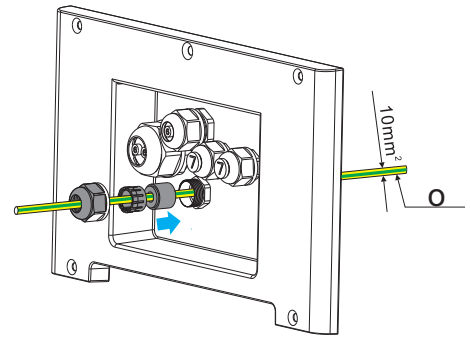

8. Strip the grounding cable and make the length ( L on the right drawing ) stripped 2-3 mm longer than the tube of the conductor ( E on the right drawing ).

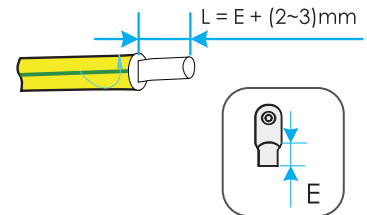

9. Get the heat shrink tubing through the cable and plug the conductor on the cable.

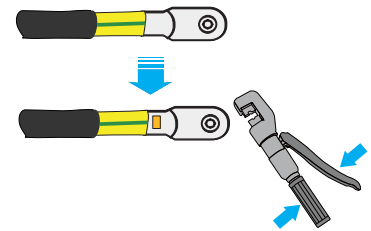

10. Squeeze the tube of the conductor with a crimping plier.

11. Get the heat shrink tubing back to cover the connection part of the cable and the conductor.

12. Blow the heat shrink tubing with hot wind.

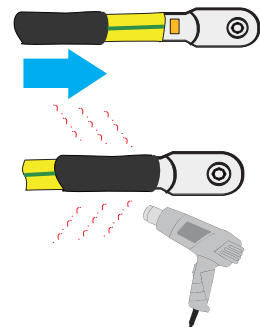

13. Take the original nut on the grounding point off, then fix the PE conductor, using the same nut, with a cylinder screwdriver 8 mm, and tighten it (torque, 4 Nm).

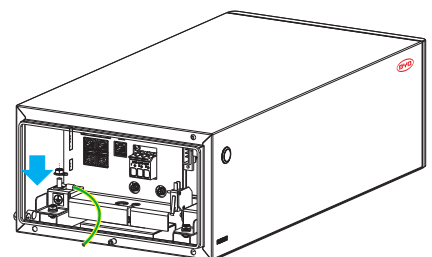

## 6.4. The Data Cable Connection to Inverter

### 6.4.1. Connection Options

The connection options with different inverters could be read in the Appendix.

### 6.4.2. Connecting the Data Cable of the Inverter

#### **⚠ QUALIFIED PERSON**

Additionally required mounting material (not included in the scope of delivery):

One data cable

**Data cable requirements:**

The cable length and quality affect the quality of the signal. Observe the following cable requirements.

Cable category: Cat5, Cat5e or higher

Plug type: Metal shielded RJ45 of Cat5, Cat5e or higher

Shielding: Yes

UV-resistant for outdoor use

Straight- through wired cables

Maximum cable length: 20m.

**Procedure:**

1. Take off the nut of the cable gland b.
2. Take the cable support sleeve inside of the cable gland.
3. Take out the plug and get the data cable inside of the cable support sleeve. **IF ONLY ONE HOLE OF THE CABLE GLAND B IS USED, PLEASE MAKE SURE THE OTHER HOLE IS WELL COVERED BY THE PLUG BEFORE FINISHING INSTALLATION. OTHERWISE, THE WATER HAS THE POSSIBILITY TO GET INSIDE OF BCU.**
4. Lead the data cable through cable gland b.
5. Plug the cable to RJ45 port or to the 8 pin terminal block.
6. Swipe the corresponding dip switch (CAN Inver or RS485 Inver) to the ACT. position (left side, this is not applicable for Kostal MP Plenticore). (Choosing CAN Inver or RS485 Inver depends on the protocol that the inverter adapted to communicate with the battery system.)

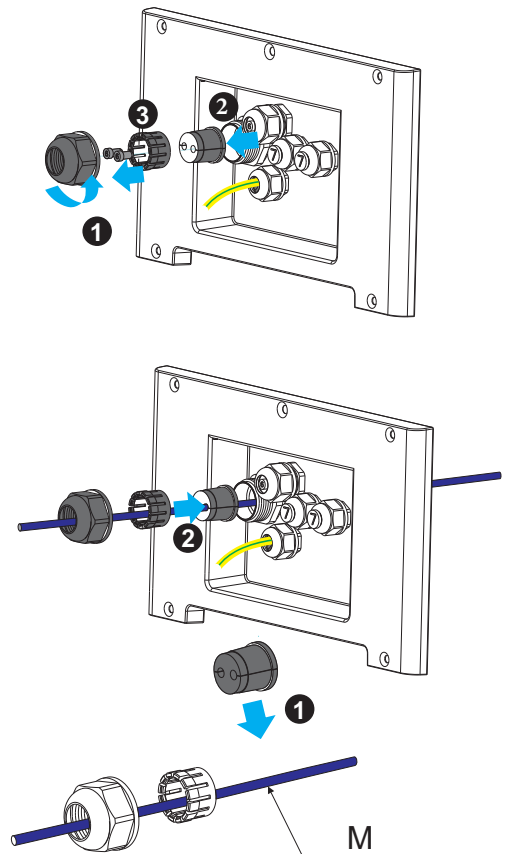

**The method to plug the data cable into the 8 pin terminal block:**

1. Strip the communication cable 50 mm.
2. Trim the cable shield to a length of 10 mm and fold it over the cable sheath.
3. Strip the insulation on the insulated conductors each by 6 mm. The CAN L and CAN H (or 485a and 485b) must be a twisted pair.

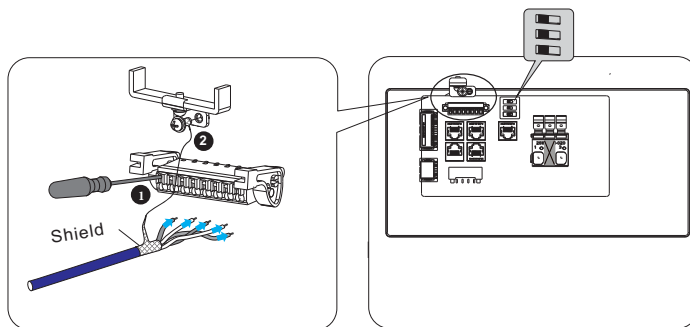

4. If necessary, trim unused insulated conductors flush with the cable sheath or fold it over the cable sheath.
5. Press the button with a flat-head screwdriver, as shown in the drawing.
6. Plug the conductors into the 8 pin terminal blocks. Pay attention to the assignment of the terminal block and communication connection on the inverter.

Make sure that the conductors are plugged into the terminal points tightly by pulling slightly on the conductors.

7. Ground the shielding to the screw above.

**6.5. Connecting the Data Cable for other Battery System(s)**

**⚠ QUALIFIED PERSON**

This connection could only need to be made when two or three battery systems to be connected in parallel. (The following section and restrictions do not apply for parallel connection with SMA Sunny Boy Storage 3.7-6.0. Please check the inverter operation manual on how to connect up to three batteries.)

The connection diagram of two battery systems could be read below.

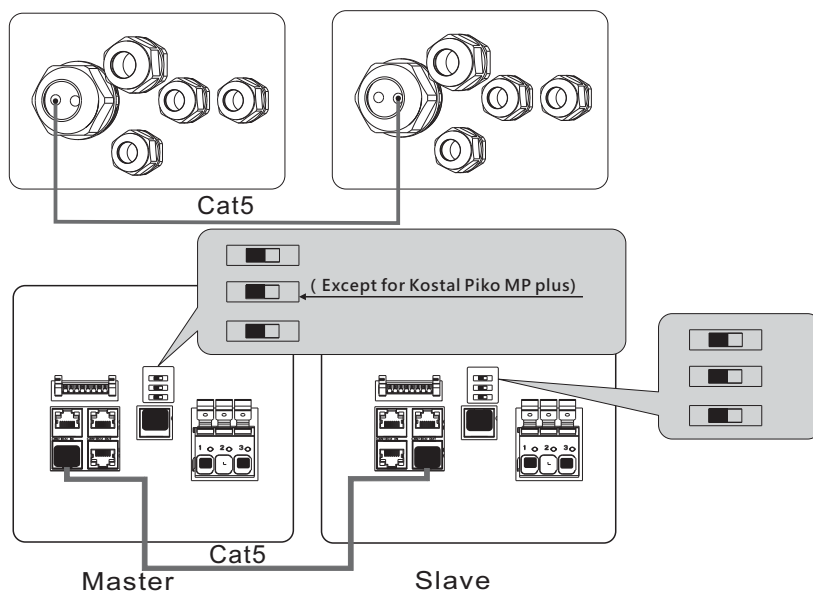

The connection diagram of three battery systems could be read below.

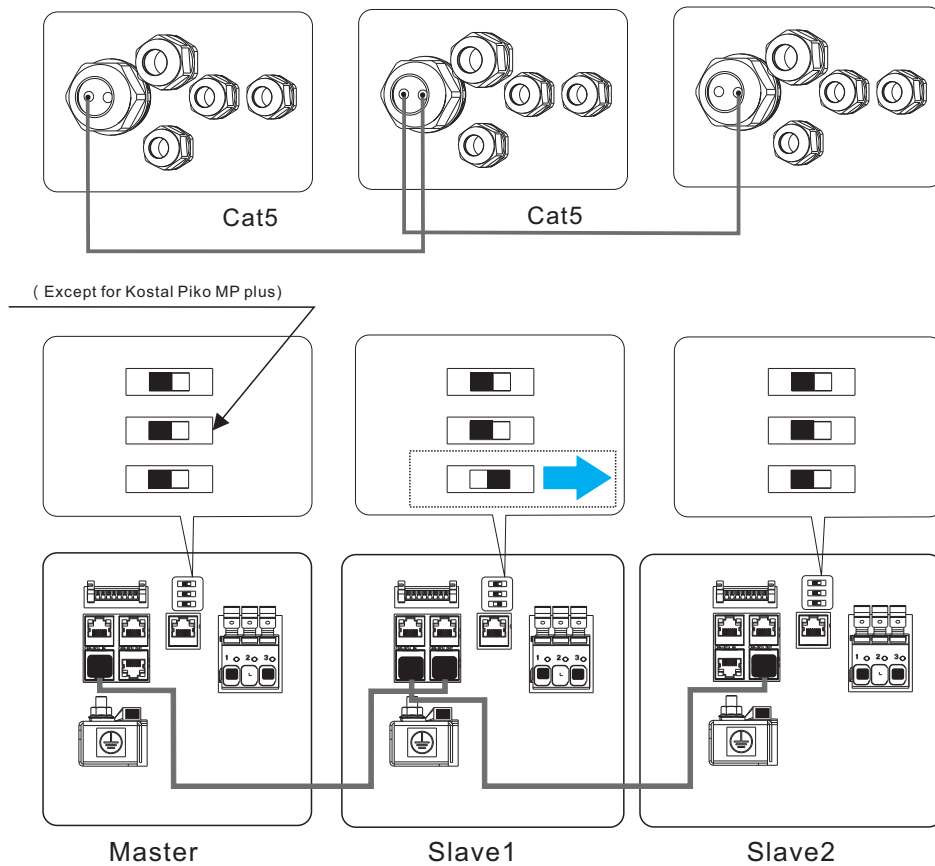

**Additionally required material (not included in the scope of delivery):**

- One to two data cables

**Data cable requirements:**

The cable length and quality affect the quality of the signal. Observe the following cable requirements.

- Cable category: Cat5, Cat5e or higher
- Plug type: Metal shielded RJ45 of Cat5, Cat5e or higher
- Shielding: Yes
- UV-resistant for outdoor use
- Straight- through wired cables
- Maximum cable length: 20 m.

**Procedure:**

1. Take off the nut of the cable gland b.
2. Take the cable support sleeve inside of the cable gland.
3. Take out the plug and get the data cable inside of the cable support sleeve. **IF ONLY ONE HOLE OF THE CABLE GLAND B IS USED, PLEASE MAKE SURE THE OTHER HOLE IS**

**WELL COVERED BY THE PLUG BEFORE FINISHING THE INSTALLATION. OTHERWISE, THE WATER HAS THE POSSIBILITY TO GET INSIDE OF BCU.**

4. Lead the data cable through cable gland b.
5. Plug the cable to the corresponding RJ45 port.
6. Swipe the dip switch (Parallel) according to the drawing.

## 6.6. Connecting the Network Cables

### DANGER

#### **Danger to life due to electric shock in case of overvoltages and if surge protection is missing**

Overvoltages (e. g. in the event of a flash of lightning) can be further conducted into the building and to other connected devices in the same network via the network cables or other data cables if there is no surge protection. Touching live parts and cables results in death or lethal injuries due to electric shock.

- Ensure that all devices in the same network and the battery are integrated into the existing surge protection.
- When laying the network cables or other data cables outdoors, it must be ensured that a suitable surge protection device is provided at the transition point of the cable from the system or the inverter outdoors to the inside of a building.

The connection to the Internet is not mandatory, but recommended.

#### **Additionally required material (not included in the scope of delivery):**

- One network cable (Cat5, Cat5e or higher)

#### **Data cable requirements:**

The cable length and quality affect the quality of the signal. Observe the following cable requirements.

- Cable category: Cat5, Cat5e or higher
- Plug type: Metal Shielded RJ45 of Cat5, Cat5e or higher
- Shielding: Yes
- UV-resistant for outdoor use
- Straight- through wired cables
- Maximum cable length: 20m.

#### **Procedure:**

1. Take off the nut of the cable gland a.
2. Take the cable support sleeve inside of the cable gland.
3. Take out the plug and get the network cable inside of the cable support sleeve.

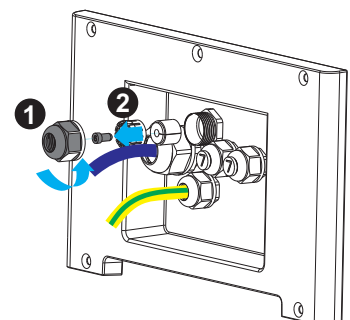

4. Lead the network cable through cable gland a.
5. Plug the cable to the corresponding RJ45 port.

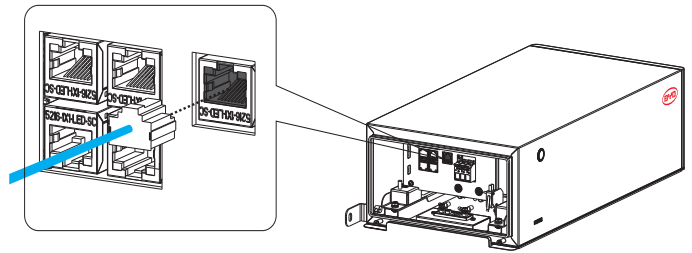

## 6.7. DC Connection

### DANGER

#### **Danger to life from electric shock due to live DC cables or conductors at the battery system**

The DC cables connected to the battery system may be live. Touching the DC conductors or the live components leads to lethal electric shocks.

- Do not touch non-insulated cable ends.

When two or three battery systems are connected, the positive power cable length of all the battery systems should be approximately equal. And so are the negative power cables. Battery-Box Premium HVS\_HVM Combiner Box or Y-Bridge connectors are needed to combine these cables. You can refer to Battery-Box Premium HV Combiner Box related documents, which are available at our website. Please also follow the local, state, provincial, federal, or national laws, regulations, and instructions from the inverter manufacturer if you choose Y-Bridge connectors.

#### **Additionally required mounting material (not included in the scope of delivery):**

Two DC power cables

#### **Cable requirements:**

- Conductor cross-section: 6 to 16 mm<sup>2</sup>. The diameter of the cable should be between 4 mm to 9 mm. Follow the requirements of the inverter manufacturer.
- Insulation stripping length: 16-18 mm
- Maximum cable length: 20 m

#### **Procedure**

1. Take off the nut of the cable glands d and e.
2. Guide each cable through the cable glands d and e.
3. Push the terminal lever up.
4. Insert each conductor into the corresponding terminal point.
5. Pull the terminal lever down.
6. Ensure that the terminal points are allocated to the correct conductors.
7. Ensure that the conductors are plugged completely into the terminal points up to their insulation.

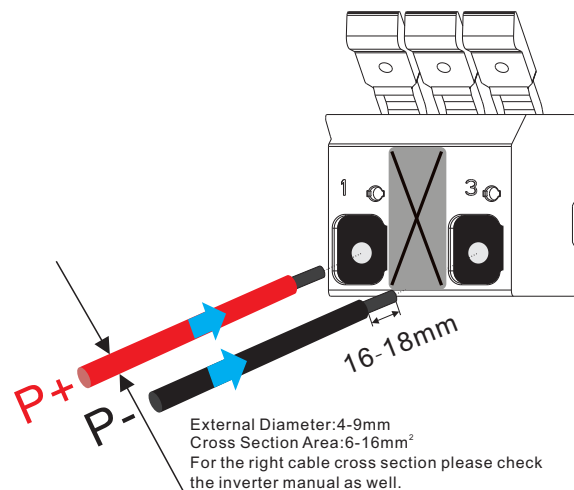



## 6.8. Close up

### Procedure:

1. Leave a small gap between the BCU and Operating Panel, so that one hand could hold data cables there.
2. Hold data cables between the BCU and Operating Panel with one hand, and tighten the nuts on grand a and b with another hand.

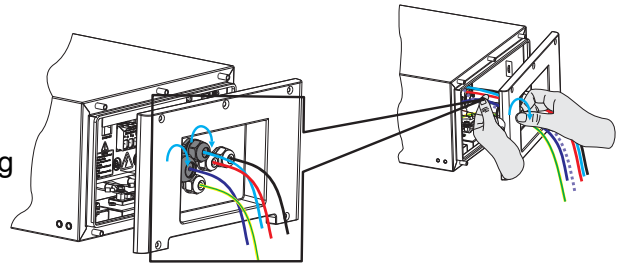

3. Fix the Operating Panel. To do this, insert the screws (M4x14) through the holes on them, using a Phillips screwdriver (PH2) and tighten it (torque: 2 Nm).

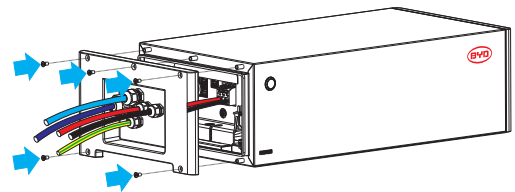

**PLEASE NOTE THAT IF THE PANEL IS NOT CLOSED, THE BATTERY CANNOT BE TURNED ON.**

4. Tighten the nuts on cable glands c, d, and e.
5. **PLEASE MAKE SURE THE SCREWS AND NUTS ARE FIXED WELL. FAILURE TO DO SO WILL MAKE ANY MANUFACTURER'S WARRANTY, GUARANTEE OR LIABILITY NULL AND VOID.**

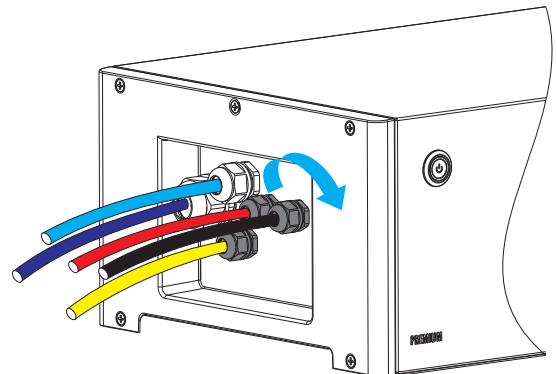

## 7. Commissioning

### 7.1. Switch on the Battery System

#### ⚠ QUALIFIED PERSON

#### Requirements:

- The power cable connection between the battery system and the inverter is switched off.
- The inverter must be correctly mounted.
- All cables must be correctly connected.
- The Operating Panel is well fixed.

#### Procedure:

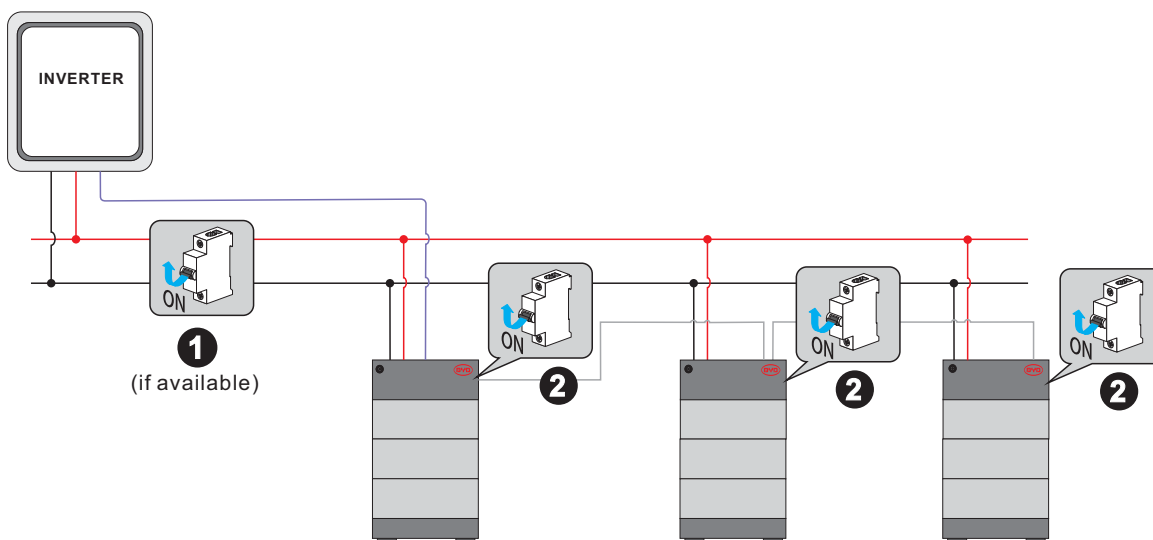

1. Switch on the system switch between the battery and inverter if there is any.
2. Open the plastic cover on the right side of the BCU.
3. Push up the System Switch from the Off position to On.
4. The LED starts to flash (0.5s white, 0.5s blue). Then it turns to flash white once and blue three times or eleven times.
5. If it is failed to switch on the battery system, check if all the electrical connection is correct.
6. **IF THE ELECTRICAL CONNECTION IS CORRECT, BUT THE BATTERY SYSTEM IS STILL UNABLE TO SWITCH ON, CONTACT OUR LOCAL AFTER-SALE SERVICE WITHIN 48 HOURS.**

## 7.2. Configure the Battery System

### **⚠ QUALIFIED PERSON**

#### Procedure:

1. Download Be Connect from Google Play or App Store. The battery system requires the latest version firmware to operate. So please make sure you either have downloaded the latest firmware in your device (cell phone, Ipad, etc.), or your device could access the Internet during configuration.



2. Allow Be Connect to access photos, media, and files on your device (this is for Android system), and choose the language. Currently, there are six languages available, English, Chinese, German, Spanish, French, and Italian.

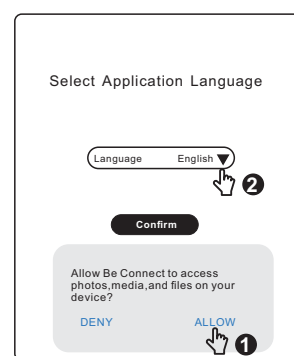

3. Click anywhere of the Welcome Page to pass through.
4. Read the privacy policy and click the Confirm button to go to the next page. You can also download the full PDF document by clicking the Download button, which requires the Internet available on your device.

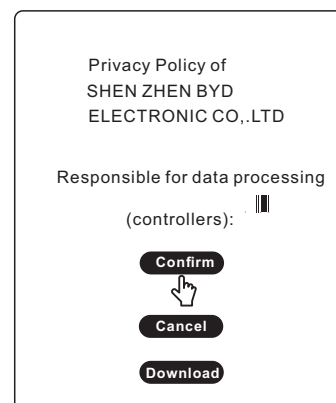

5. The app will start to download the firmware and Parameter Tables from the internet automatically.

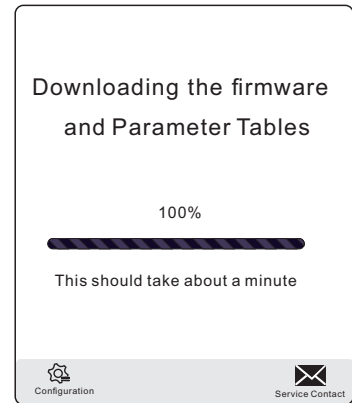

6. Connect the WLAN of the battery system. If there are three battery systems connected in parallel, connect the WLAN of the master system. You can identify the WLAN by reading the label on BCU and the label on the last page of the Quick Start Guide. All the WLAN shares the common password (BYDB-Box). Turning off the Cellular Data and disconnecting the battery system Ethernet cable at the router side will be good for the WLAN connection between the battery system and your device.

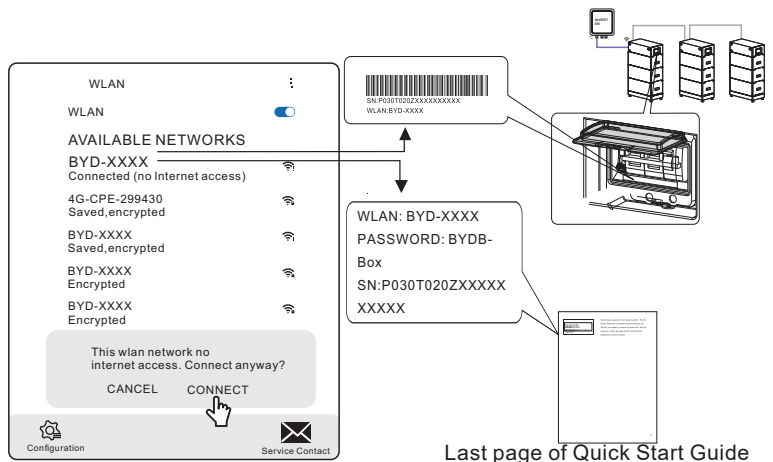

The WLAN of the slave systems will turn off automatically after the battery system starts to communicate with the inverter.

7. Click the Continue button to update.

8. On the configuration page, click Confirm to set time.

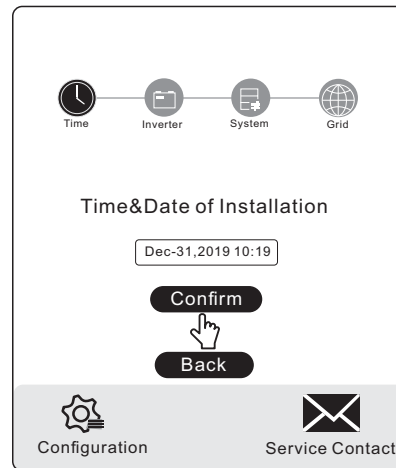

9. Choose an inverter brand.

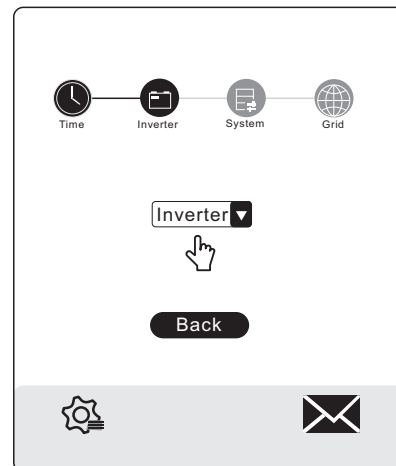

10. Choose the battery system model, HVM or HVS. (HVL is only available for the US market.) And then, set how many battery modules are installed per tower.

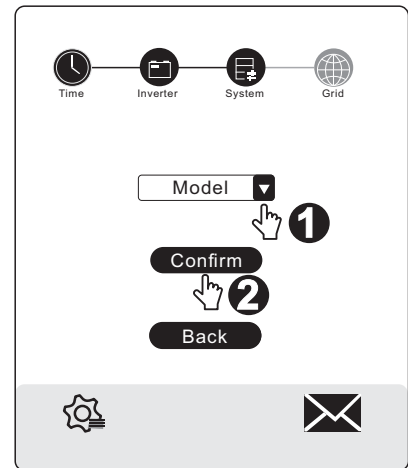

11. Choose the Grid and Phase options according to the actual application.

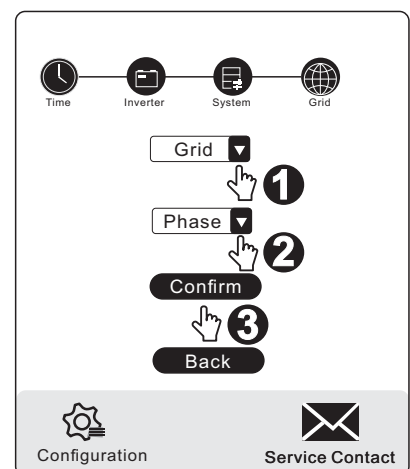

12. Check the summary of the configuration information, tick the sentence, and click Submit.

If there is a prompt or Submit button is grey, wait a moment and check the WLAN connection.

There will be a prompt "Succeeded" when the configuration is completed.

Restart the Be Connect if it was stuck somewhere.

Please note that the SOC of the battery may not be accurate before a full charge or discharge after the configuration.

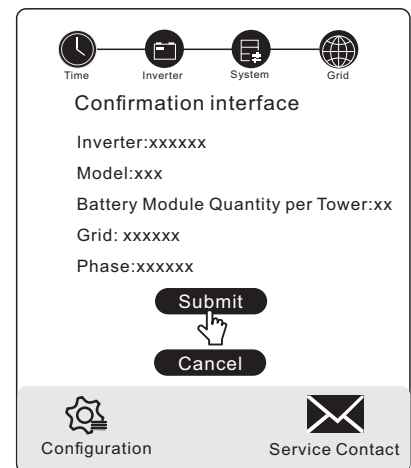

### 7.3. Switch on and Commission the Inverter

#### ⚠ QUALIFIED PERSON

#### Procedure:

1. Mount and connect the inverter according to the inverter manufacturer`s instruction.
2. Commission and configure the inverter according to the inverter manufacturer`s instruction.

If the battery information could be read correctly, it means the connection between the battery system and the inverter is all right. Normally, the LED of the battery will also turn to white then, and the battery system is ready to work.

If LED of BCU still flashes blue, and/or there are some battery errors shown at the inverter, go to the Trouble Shooting Chapter of this manual.

## 8. Operation

### 8.1. Switch on the Battery System

To make sure the battery system can work well with the inverter, please follow the right procedure to start them. The procedure is: 1) turn on the switch between the inverter and battery if there is any; 2) switch on the battery system; 3) switch on the inverter.

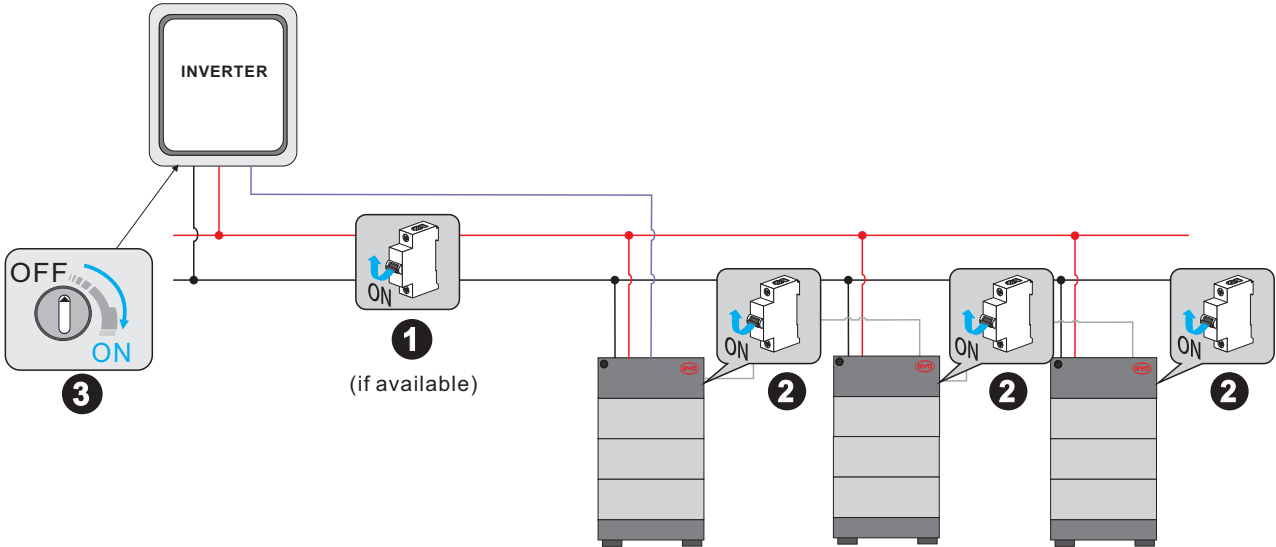

### 8.2. Switch off the Battery System

The procedure to switch off the battery system is: 1) switch off the inverter; 2) switch off the battery; 3) switch off the system switch between the battery and the inverter if there is any.

The correct way to switch off the battery system is to press the LED Button for 5 seconds on the BCU, but not to pull down the system switch of BCU.

If two or three battery systems are connected in parallel, only the LED Button on the master system needs to turn off. The slave system(s) will be turned off automatically.

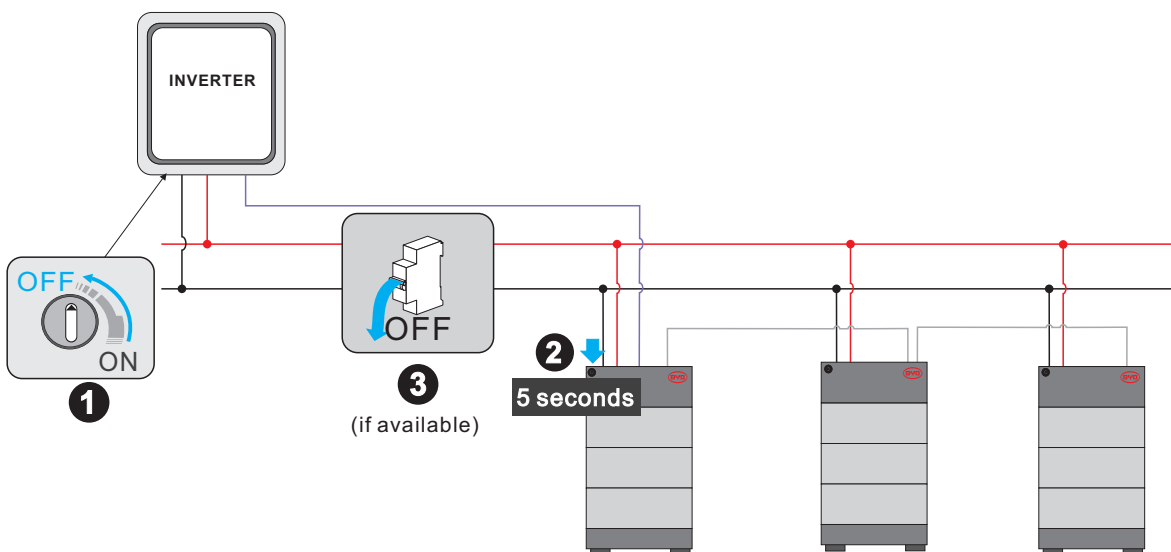

### **8.3. Safety Design**

The battery system cannot be turned on when the Operating Panel is removed.

The system will switch off automatically if there is no communication with an inverter for 30 minutes.

### **8.4. Black Start Function**

The battery system could support the black start function of compatible inverters. The ways to trigger this function are different when the battery systems are operated with different inverters.

### **8.5. WLAN**

The WLAN of the battery system will be disappeared in five hours after the system started. Restart the system or press the LED button around one second while the system is on could activate the WLAN again.

Press the LED button for three times (each time around one second) within six seconds could reset the battery WLAN.



## 9. Decommissioning

### ⚠ QUALIFIED PERSON

#### ⚠ DANGER

##### **Danger to life from electric shock due to live DC cables or conductors at the battery system**

The DC cables connected to the battery system may be live. Touching the DC conductors or the live components leads to lethal electric shocks.

- Do not touch non-insulated cable ends.

#### ⚠ CAUTION

##### **Risk of injury due to weight of the battery module**

Injuries may result if the battery module is lifted incorrectly or dropped while being transported or installed.

- Transport and lift the battery module carefully. Take the weight of the battery module into account.
- Wear suitable personal protective equipment for all work on the battery system.

#### **Procedure:**

1. Shut off the inverter.
2. Switch off the battery system.
3. Switch off the breaker between the inverter and the battery system if there is any.
4. Take off the nuts on the cable glands on Operation Panel.
5. Loose the screws on Operation Panel.
6. Remove all cables from the battery system.
7. Loosen the screws on hangers between BCU and the wall. And then take off the hangers.
8. Tighten the nuts on the cable glands on the Operation Panel.
9. Fix the Operation Panel on the BCU.
10. Take the BCU from battery modules and battery modules from the base.

Before lifting the battery module, ensure that the screws on both sides of them are removed.

11. Remove the hangers (BCU part).

If the battery system is to be stored or shipped, pack the system. Use the original packaging or packaging that is suitable for the weight and dimensions of the system.

Dispose of the battery system in accordance with the locally applicable disposal regulations for electronic waste.

## 10. Extension

The SOC of the existing system and the module to be added should be similar before the module adding on the existing system.

### Procedure:

1. Charge or discharge the existing system to an SOC of around 30% SOC. Note: New modules have an SOC of around 30%.
2. Shut off the inverter.
3. Switch off the battery system.
4. Switch off the breaker between the inverter and the battery system if there is any.
5. Take the BCU off.
6. Add the new module on top of other battery modules.
7. Put BCU back on top of the new battery module.
8. Configure the battery system.
9. Start the inverter.

New Battery  
SOC  $\approx$  30%



Original Battery  
SOC  $\approx$  30%

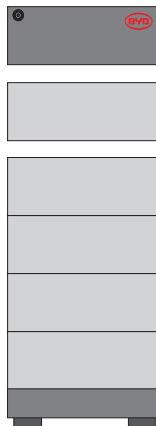

Be Connect

# 11. Troubleshooting

Please also see the Battery-Box Premium HVS/HVM Service Guideline and Checklist for troubleshooting. The latest version is available at our website [www.bydbatterybox.com](http://www.bydbatterybox.com).

## 11.1. Battery System Behavior under Fault Conditions

### Blue light flashing

If blue LED flashes, and the interval time between two flashes is 1 second, which means an error happened. (When the system is initiating, the white light and blue light flash alternatively every 0.5s. That is not an error.)

The detailed designation for errors of each LED lights could be read in 11.2.

Please note that if the communication with the inverter is not established, the blue light may flash three or eleven times. So when it happens, check the communication with the inverter first.

Except the LED light, BYD service team can also get the faulty messages of the battery through the remote server. Information read through the remote server will help a lot to identify the issue. So highly recommend to connect the battery system to the Internet.

### NOTICE

#### Damage to the battery system due to under voltages

- If the battery system doesn't start at all, please contact BYD local after-sales service within 48 hours. Otherwise, the battery could be permanently damaged.

### WLAN is not available

Refer to Section 8.5. If the WLAN is still not available, contact with BYD local after-sales service.

### BCU is not able to turned on

Check the system has been constructed according to the Battery-Box Premium Compatible Inverter List. Also please make sure the inverter is off before turning on the battery. If the problem still cannot be solved, refer to the Service Guideline. If problem remains, contact with BYD local after-sales service.

### BCU cannot be turned off

Refer to the Service Guideline. If problem remains, contact with BYD local after-sales service.

## 11.2. LED Light Designation for Errors

Blue LED is flashing once	DC cable connection incorrect
Blue LED is flashing twice	a precharge transistor or relay failure
Blue LED is flashing three times	BIC (battery information collector) communication failed
Blue LED is flashing four times	Battery sensor failure
Blue LED is flashing five times	Reserved
Blue LED is flashing six times	Current sensor failure
Blue LED is flashing seven times	Battery failure

---

Blue LED is flashing eight times	Precharge failed
Blue LED is flashing nine times	BIC balancing failed
Blue LED is flashing ten times	Reserved
Blue LED is flashing eleven times	BMS and BMU communication failure
Blue LED is flashing twelve times	Inverter communication failure
Blue LED is flashing thirteen times	Address registration failed
Blue LED is flashing fourteen times	System parameters loading failed

---

## 12. Maintenance and Storage

### Cleaning

It is recommended that the battery system be cleaned periodically. If the enclosure is dirty, please use a soft, dry brush or a dust collector to remove the dust. Liquids such as solvents, abrasives, or corrosive liquids should not be used to clean the enclosure.

### Maintenance

The battery module should be stored in an environment with a temperature range between  $-10^{\circ}\text{C}$  ~  $+50^{\circ}\text{C}$ , and charged regularly according to the table below with no more than 0.5 C (A C-rate is a measure of the rate at which a battery is discharged relative to its maximum capacity. ) to the SOC of 40% after a long time of storage.

Storage environment temperature	Relative humidity of the storage environment	Storage time	SOC
Below $-10^{\circ}\text{C}$	/	Not allowed	/
$-10\sim 25^{\circ}\text{C}$	5%~70%	$\leq 12$ months	$25\% \leq \text{SOC} \leq 60\%$
$25\sim 35^{\circ}\text{C}$	5%~70%	$\leq 6$ months	$25\% \leq \text{SOC} \leq 60\%$
$35\sim 50^{\circ}\text{C}$	5%~70%	$\leq 3$ months	$25\% \leq \text{SOC} \leq 60\%$
Above $50^{\circ}\text{C}$	/	Not allowed	/

### NOTICE

#### Damage to the system due to under voltages





- Charge the over-discharged system within seven days when the temperature is above  $25^{\circ}\text{C}$ .
- Charge the over-discharged system within fifteen days when the temperature is below  $25^{\circ}\text{C}$ .







## 13. Disposal of the Battery System

Disposal of the system must comply with the local applicable disposal regulations for electronic waste and used batteries.

- Do not dispose of the battery system with your household waste.
- Avoid exposing the batteries to high temperatures or direct sunlight.
- Avoid exposing the batteries to high humidity or corrosive atmospheres.
- For more information, please contact BYD.

## 14. Technical Data

				
	HVS 5.1	HVS 7.7	HVS 10.2	HVS 12.8
Battery Module	HVS (2.56 kWh, 102.4 V, 38 kg)			
Number of Modules	2	3	4	5
Usable Energy [1]	5.12 kWh	7.68 kWh	10.24 kWh	12.8 kWh
Max Output Current [2]	25 A	25 A	25 A	25 A
Peak Output Current [2]	50 A, 3s	50 A, 3 s	50 A, 3 s	50 A, 3 s
Nominal Voltage	204.8 V	307.2 V	409.6 V	512 V
Operating Voltage	160~230.4 V	240~345.6 V	320~460.8 V	400~576 V
Dimensions (H/W/D)	762x585x298 mm	995x585x298 mm	1228x585x298 mm	1461x585x298 mm
Weight	91 kg	129 kg	167 kg	205 kg
Battery designation	IFpP/21/173/120/32S/M/-10+50/90			

						
	HVM 8.3	HVM 11.0	HVM 13.8	HVM 16.6	HVM 19.3	HVM 22.1
Battery Module	HVM (2.76 kWh, 51.2 V, 38 kg)					
Number of Modules	3	4	5	6	7	8
Usable Energy [1]	8.28 kWh	11.04 kWh	13.80 kWh	16.56 kWh	19.32 kWh	22.08 kWh
Max Output Current [2]	40 A	40 A	40 A	40A	40 A	40 A
Peak Output Current [2]	75 A, 3 s	75 A, 3 s	75 A, 3 s	75 A, 3 s	75 A, 3 s	75 A, 3 s
Nominal Voltage	153.6 V	204.8 V	256 V	307.2 V	358.4 V	409.6 V
Operating Voltage	120~172.8 V	160~230.4 V	200~288 V	240~345.6 V	280~403.2 V	320~460.8 V
Dimensions (H/W/D)	995 x585 x 298 mm	1228 x585 x 298 mm	1461 x585 x 298 mm	1694 x585 x 298 mm	1927 x585 x 298 mm	2160 x585 x 298 mm
Weight	129 kg	167 kg	205 kg	243 kg	281 kg	319 kg
Battery designation	IFpP/47/174/120/16S/M/-10+50/90					

Short Circuit Current	2300A	2300A	2300A	2300A	2300A	2300A
Rated Power	7.65kW	10.2kW	12.8kW	15.35kW	17.9kW	20.45kW
Max Charge Current [2]	50 A	50 A	50 A	50 A	50 A	50 A
Max Charge and Discharge power	7.65kW	10.2kW	12.8kW	15.35kW	17.9kW	20.45kW

HVS & HVM	
Operating Temperature	-10 °C to +50°C
Battery Cell Technology	Lithium Iron Phosphate (cobalt-free)
Communication	CAN/RS485
Enclosure Protection Rating	IP55
Round-trip Efficiency	≥96%
Certification	VDE2510-50 / IEC62619 / CEC / CE / UN38.3
Applications	ON Grid / ON Grid + Backup / OFF Grid
Warranty [3]	10 Years

[1] DC Usable Energy, Test conditions: 100% DOD, 0.2C charge & discharge at +25°C. System Usable Energy may vary with different inverter brands.

[2] Charge derating will occur between -10°C and +5°C.

[3] Refer to BYD Battery-Box Premium Limited Warranty.



## 15. Contact Information

Note: Please also see the Battery-Box Premium HVS/HVM Service Guideline and Checklist for troubleshooting. The latest version is available at our website [www.bydbatterybox.com](http://www.bydbatterybox.com).

---

### BYD Global Service

bboxservice@byd.com

Telephone: +86 755 89888888-47175

Address: No.3009, BYD Road,  
Pingshan, Shenzhen, 518118, P.R. China

[www.bydbatterybox.com](http://www.bydbatterybox.com)

Social media link

<https://www.facebook.com/BatteryBoxBYD/>

[https://twitter.com/BYD\\_BatteryBox](https://twitter.com/BYD_BatteryBox)

<https://www.linkedin.com/company/byd-battery-box>

---

**Australia** Alps Power Pty Ltd  
service @alpspower.com.au  
Telephone: +61 2 8005 6688  
Address: 14/47-51 Lorraine St  
Peakhurst NSW 221  
[www.alpspower.com.au](http://www.alpspower.com.au)

**Europe** EFT-Systems GmbH  
service@eft-systems.de  
Telephone +49 9352 8523999  
+44 (0) 2037695998(UK)  
+34 91 060 22 67(ES)  
+39 02 87368364(IT)  
Address: Bruchtannenstraße 28, 63801  
Kleinostheim, Germany  
[www.eft-systems.de](http://www.eft-systems.de)

---

**South Africa** AFRIPLUS ENERGY GROUP  
(PTY) LTD  
Support@afriplusenergy.co.za  
Telephone: +27 21 140 3594  
Address: The Pavilion, Corner of  
Dock & Portswood Road, V&A  
WATERFRONT, 8001, CAPE  
TOWN

**USA** BYD US Service  
bboxuservice@byd.com  
Telephone: +1(833) 338-8721

---

# Appendix Connection Options with Inverters

Please first check if the planned configuration is already released according to the latest Battery-Box Premium HVS/HVM Compatible Inverter List before the installation.

**a** SMA SBS 2.5 / 3.7 / 5.0 / 6.0 Option a

Battery-Box

Battery-Box SBS	
PIN	PIN
4	B
3	C
2	D
1	E

Cable Length ≤ 20 m

**NOTICE**

Parallel connection is not applicable to SMA Sunny Boy Storage 3.7-6.0. Please check the inverter operation manual on how to connect up to three batteries.

**b** SMA SBS 2.5 / 3.7 / 5.0 / 6.0 Option b

Battery-Box

Battery-Box SBS	
PIN	PIN
4	B
3	C
2	D
1	E

Cable Length ≤ 20 m

Shield

**c** Kostal PLENTICORE Plus/ Plenticore BI Option a

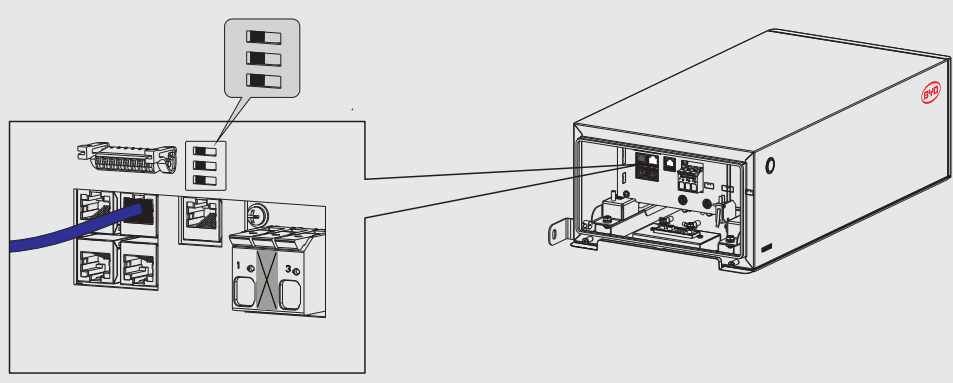
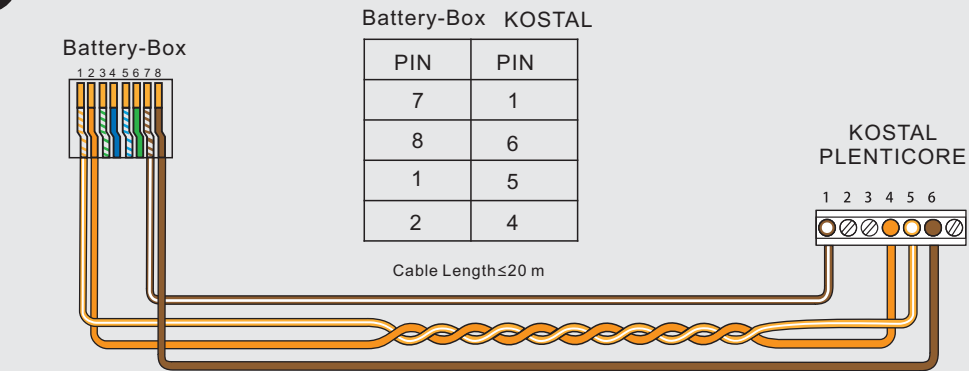

**d** Kostal PLENTICORE Plus/ Plenticore BI Option b

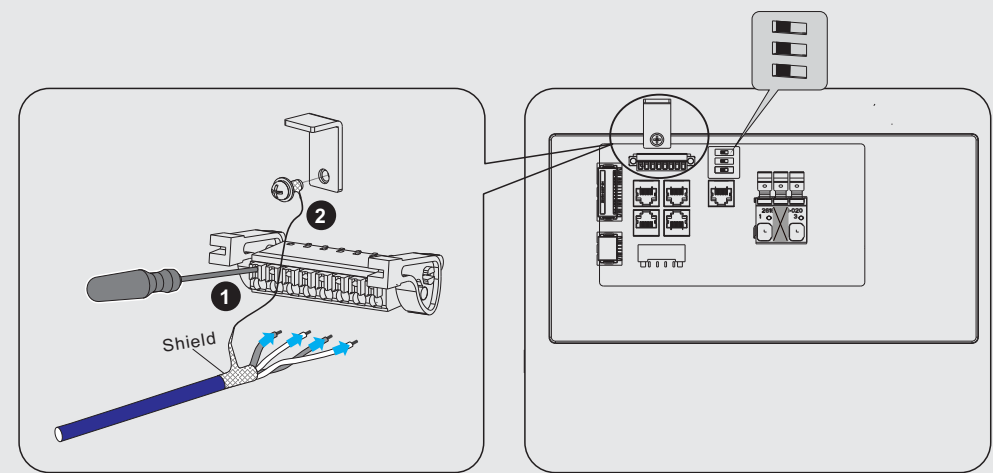
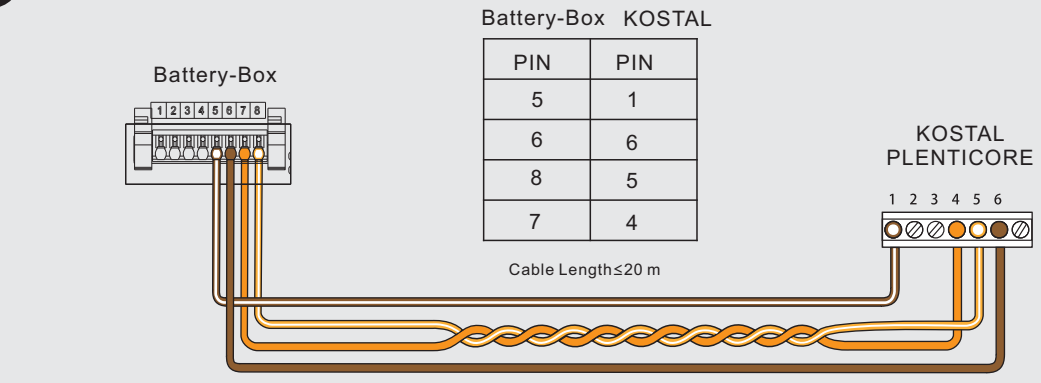

**e** Kostal PIKO MP Plus

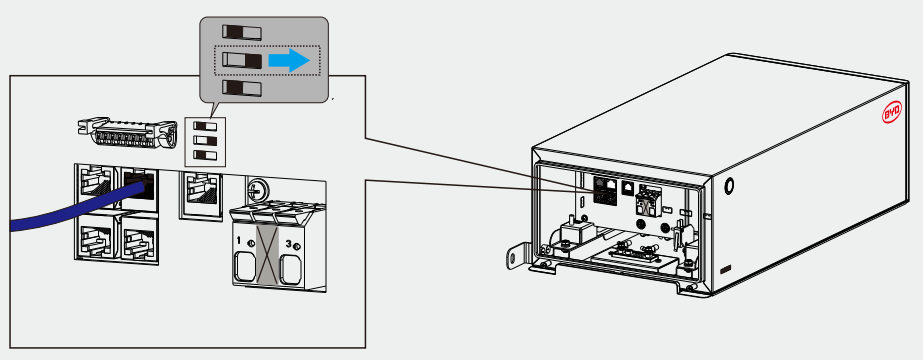
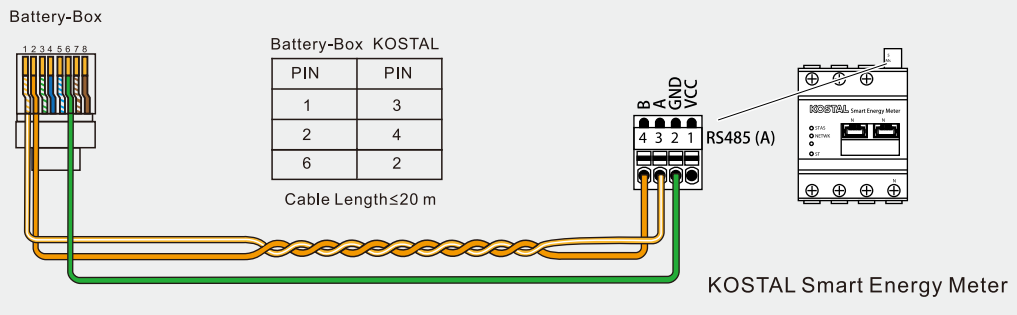

**f** Kostal PIKO BA

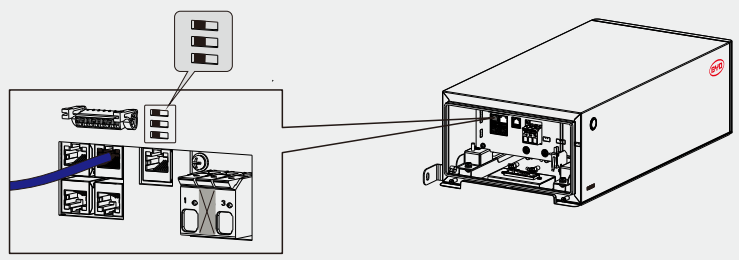
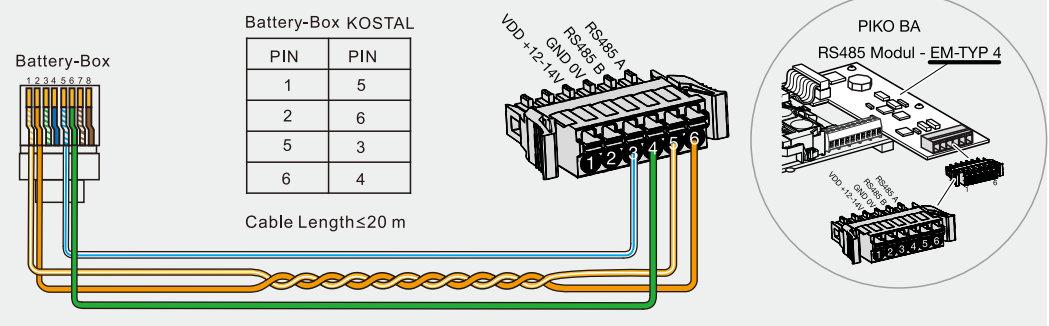

**g** Kaco blueplanet hybrid 6.0 - 10.0 TL3

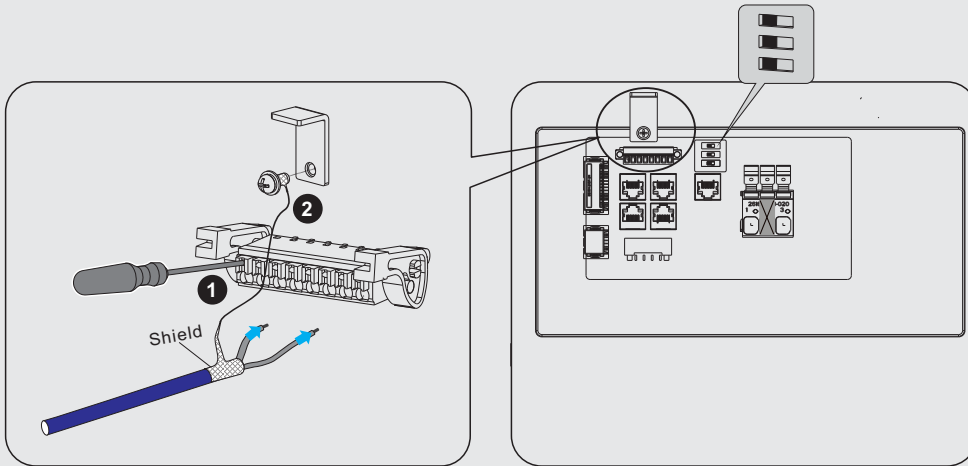
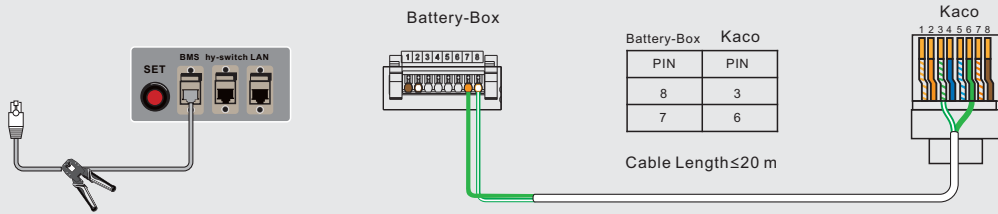

## h GoodWe/Viessmann ET/BT/BH Option a

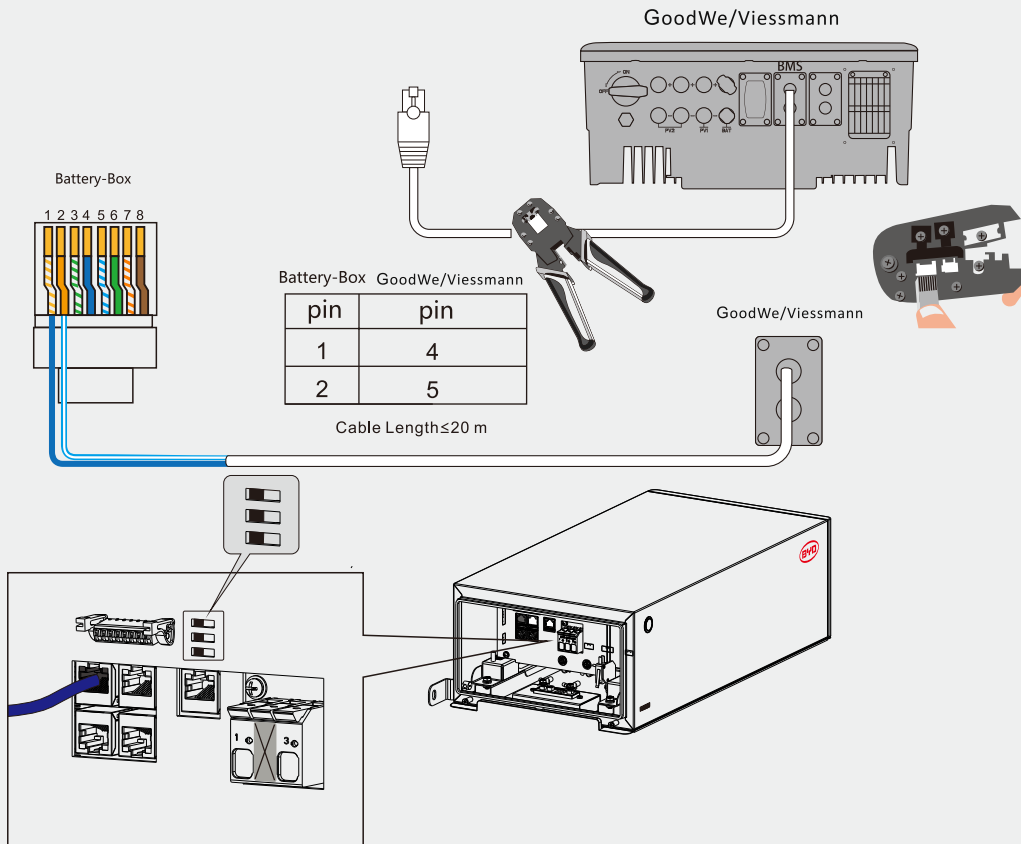

## i GoodWe/Viessmann ET/BT/BH Option b

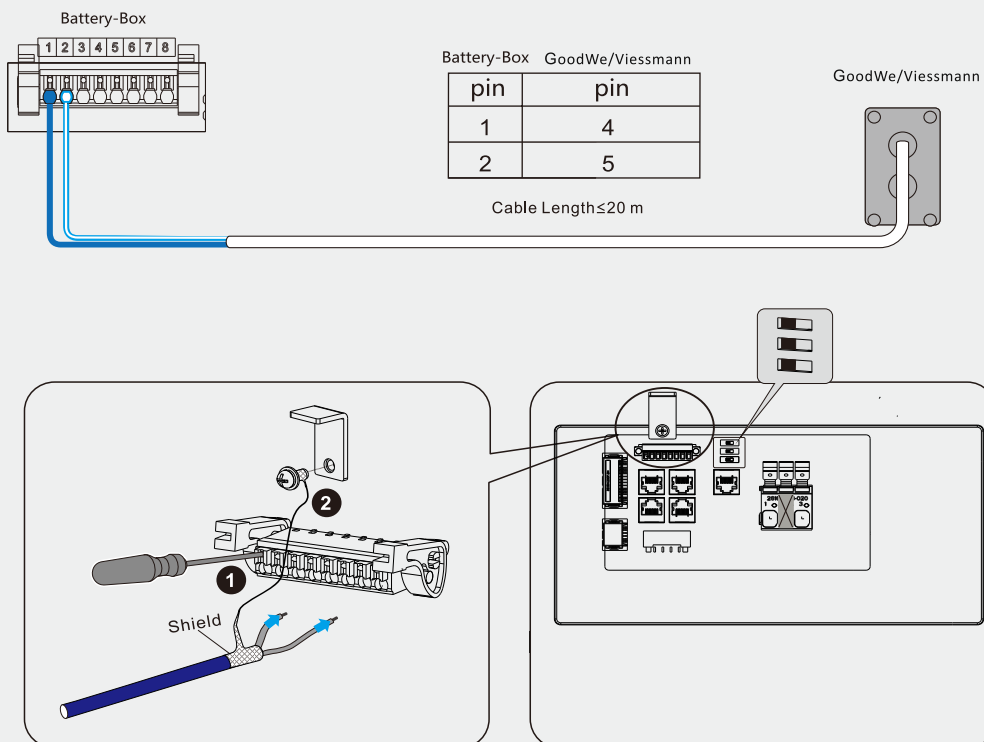

**j** SUNGROW SH5.0\_6.0\_8.0\_10RT Option a

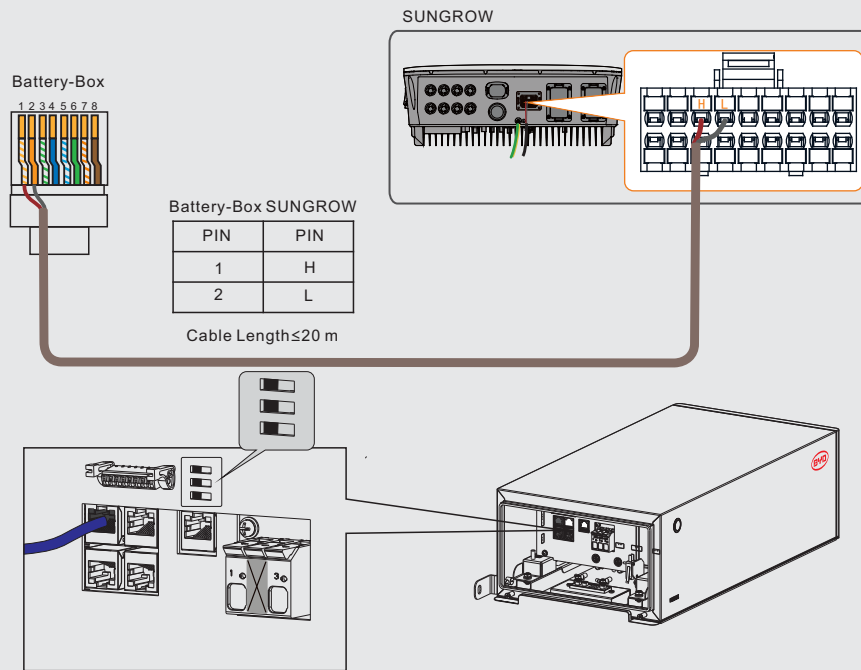

**k** SUNGROW SH5.0\_6.0\_8.0\_10RT Option b

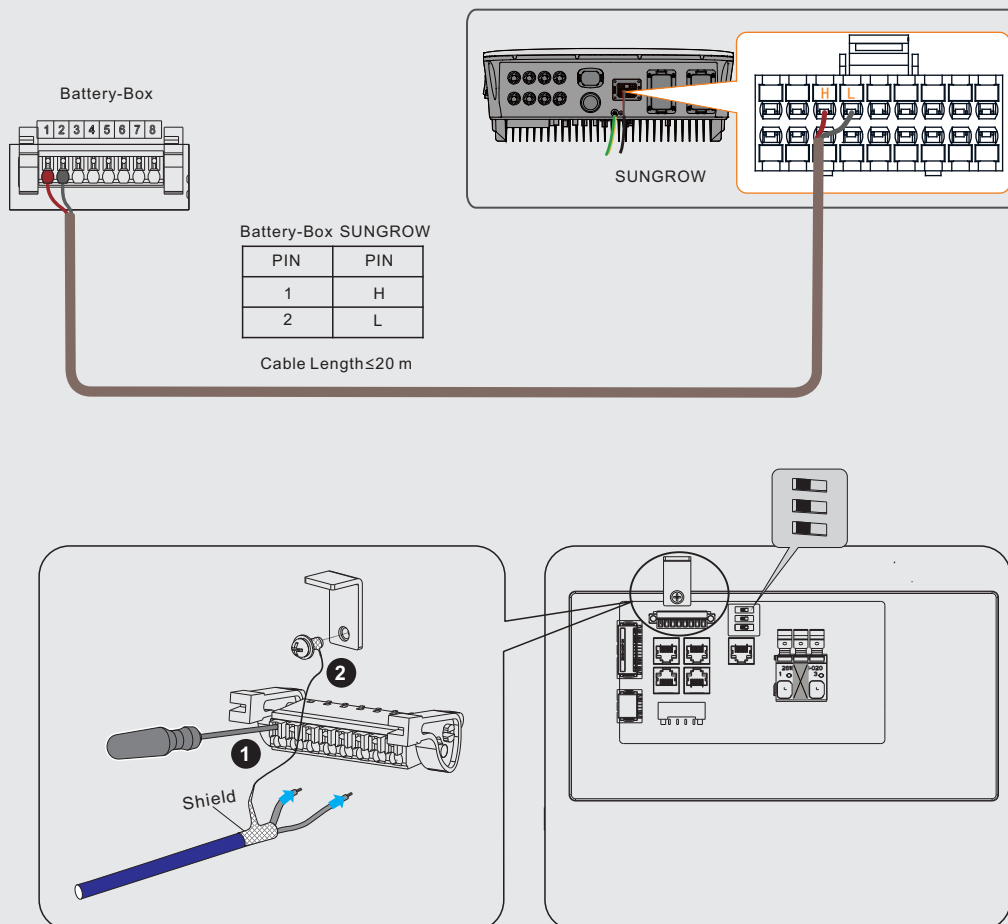

# I Fronius Symo Hybrid Option a

Battery-Box	Fronius
7	+
8	-
1	D+
2	D-

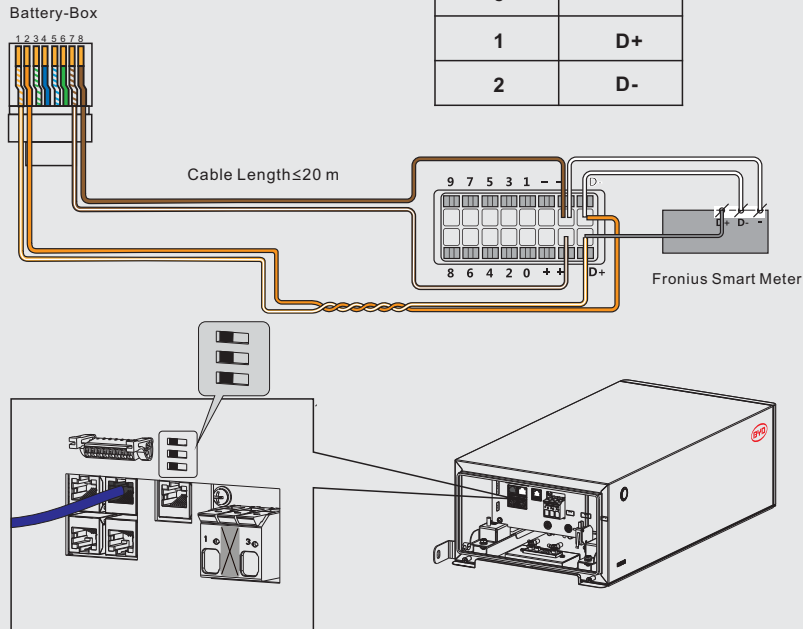

# m Fronius Symo Hybrid Option b

Battery-Box	Fronius
5	+
6	-
8	D+
7	D-

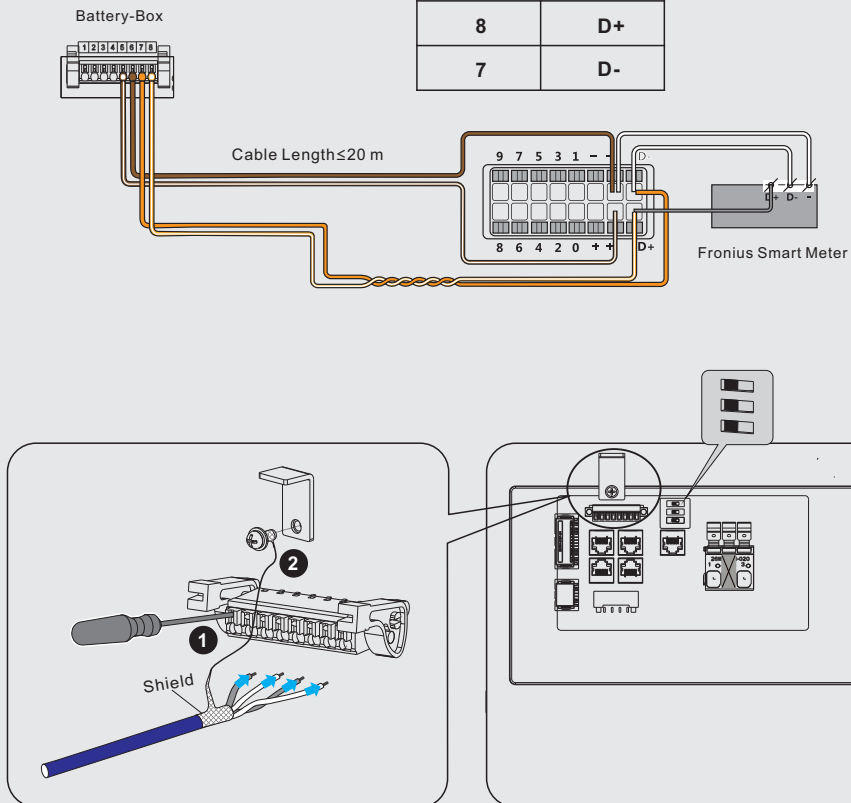



**n**

### Fronius Primo Gen24Plus/Symo Gen24Plus Option a

Battery-Box

Battery-Box      Fronius

7	v+
8	GND
1	M0+
2	M0-

Cable Length ≤ 20 m

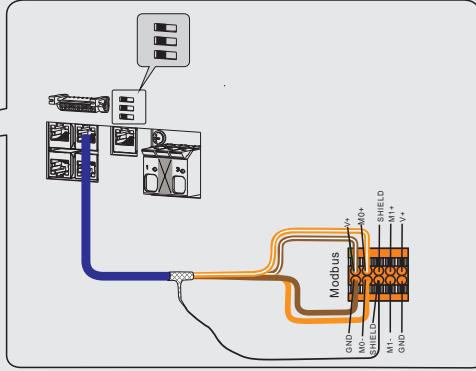
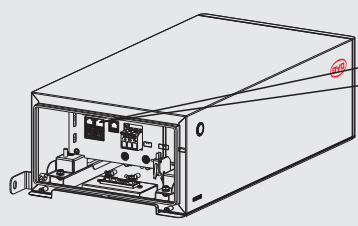
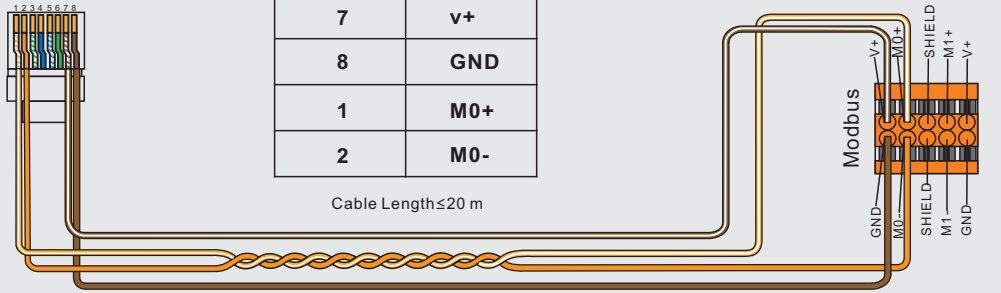

**o**

### Fronius Primo Gen24Plus/Symo Gen24Plus Option b

Battery-Box

Battery-Box      Fronius

5	v+
6	GND
8	M0+
7	M0-

Cable Length ≤ 20 m

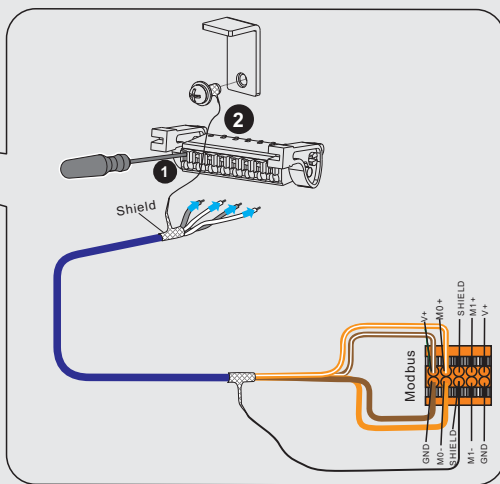
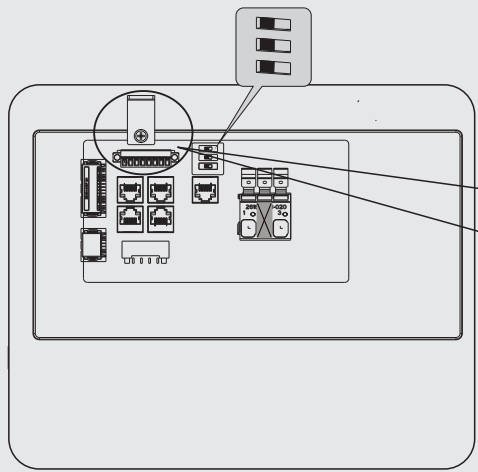
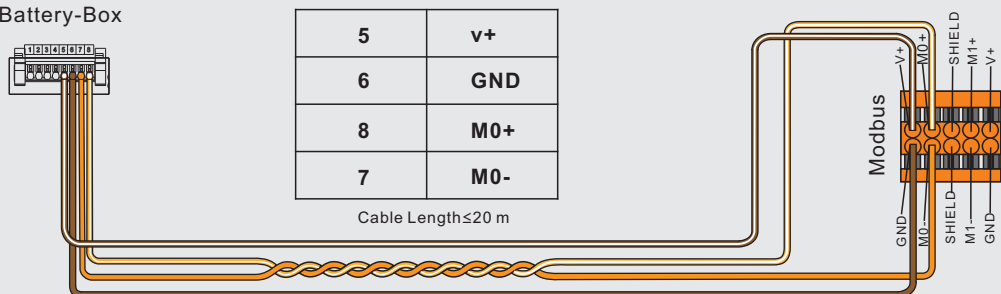

p

### Ingeteam Optiona

Battery-Box



Battery-Box Ingeteam

pin	pin
1	CAN H
2	CAN L

Cable Length ≤ 20 m

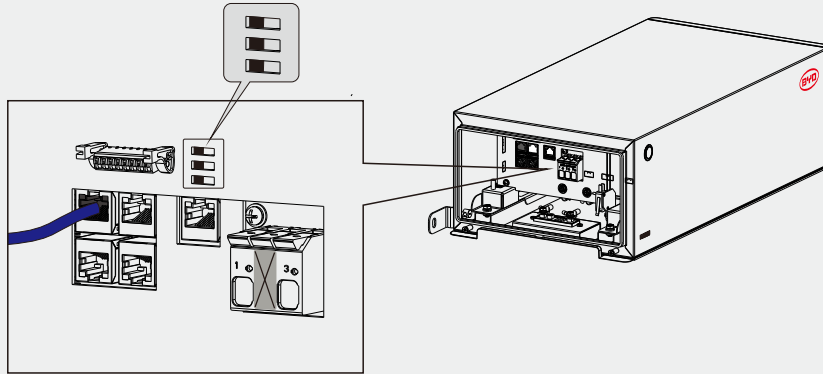
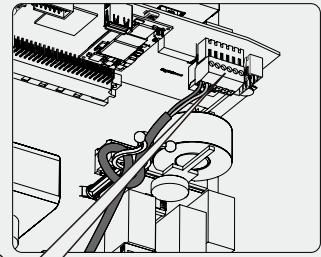
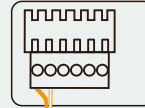

q

### Ingeteam Optionb

Battery-Box

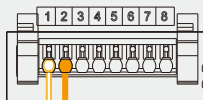

Battery-Box Ingeteam

pin	pin
1	CAN H
2	CAN L

Cable Length ≤ 20 m

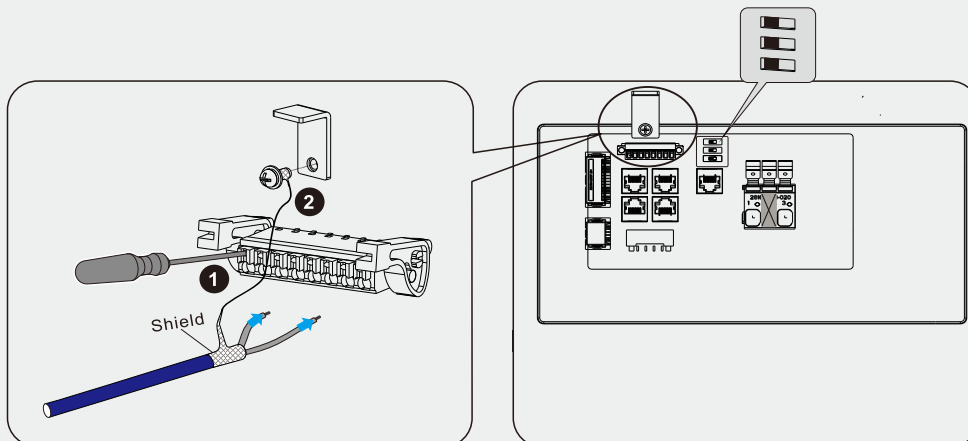
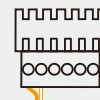

**r** Solis Option a

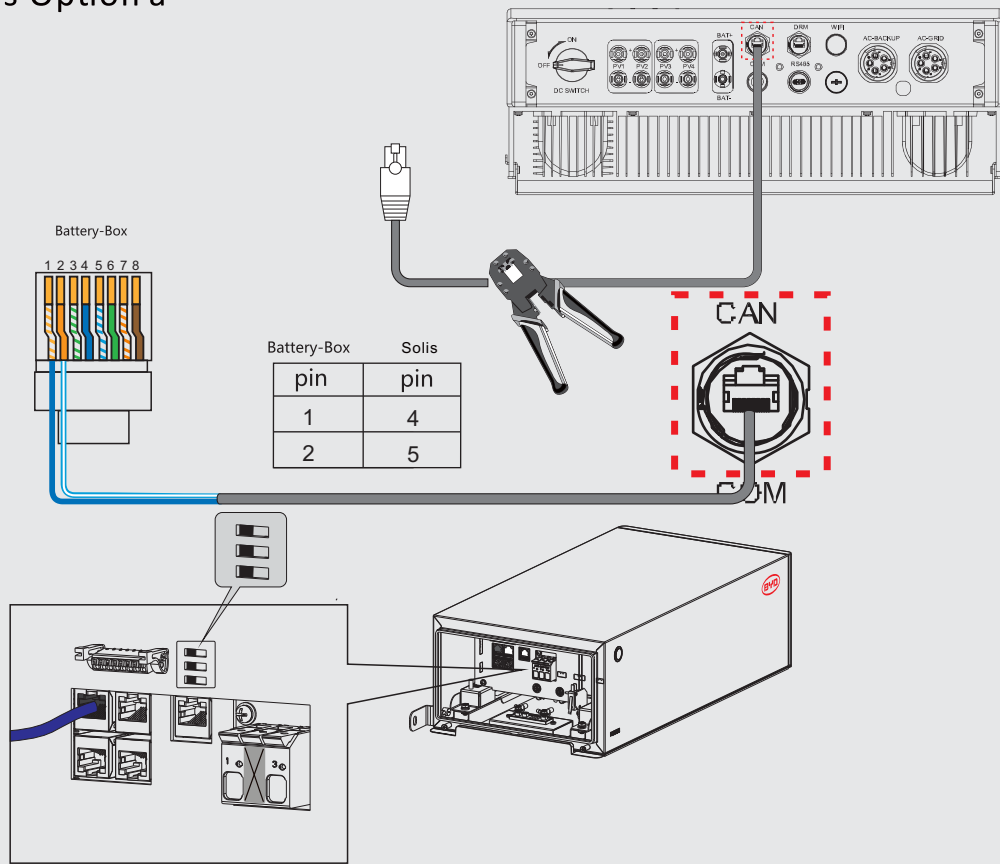

**s** Solis Option b

